



uSmart Cloud Terminal W106D

User Guide

Version: V1.24.21

ZTE CORPORATION

ZTE Plaza, Keji Road South, Hi-Tech Industrial Park,

Nanshan District, Shenzhen, P.R.China

Postcode: 518057

Tel: +86-755-26771900

URL: <https://support.zte.com.cn>

E-mail: support@zte.com.cn

LEGAL INFORMATION

Copyright 2024 ZTE CORPORATION.

The contents of this document are protected by copyright laws and international treaties. Any reproduction or distribution of this document or any portion of this document, in any form by any means, without the prior written consent of ZTE CORPORATION is prohibited. Additionally, the contents of this document are protected by contractual confidentiality obligations.

All company, brand and product names are trade or service marks, or registered trade or service marks, of ZTE CORPORATION or of their respective owners.

This document is provided as is, and all express, implied, or statutory warranties, representations or conditions are disclaimed, including without limitation any implied warranty of merchantability, fitness for a particular purpose, title or non-infringement. ZTE CORPORATION and its licensors shall not be liable for damages resulting from the use of or reliance on the information contained herein.

ZTE CORPORATION or its licensors may have current or pending intellectual property rights or applications covering the subject matter of this document. Except as expressly provided in any written license between ZTE CORPORATION and its licensee, the user of this document shall not acquire any license to the subject matter herein.

ZTE CORPORATION reserves the right to upgrade or make technical change to this product without further notice.

Users may visit the ZTE technical support website <https://support.zte.com.cn> to inquire for related information.

The ultimate right to interpret this product resides in ZTE CORPORATION.

Statement on the Use of Third-Party Embedded Software:

If third-party embedded software such as Oracle, Sybase/SAP, Veritas, Microsoft, VMware, and Redhat is delivered together with this product of ZTE, the embedded software must be used as only a component of this product.

If this product is discarded, the licenses for the embedded software must be void either and must not be transferred. ZTE will provide technical support for the embedded software of this product.

Revision History

Revision No.	Revision Date	Revision Reason
R1.1	2024-08-08	Modify Advanced Management.
R1.0	2024-06-27	First edition.

Serial Number: SJ-20240605102453-021

Publishing Date: 2024-08-08 (R1.1)

Contents

1 Safety Precautions.....	1
2 Overview.....	3
3 Packing List.....	4
4 Connecting Up.....	5
5 Technical Specification.....	6
6 First Use.....	7
6.1 Powering On the Terminal for the First Time.....	7
6.2 Network Connection.....	10
6.2.1 Connecting to a Wired Network.....	10
6.2.2 Connecting to a Wireless Network.....	14
6.3 (Optional) Setting the Cloud Server Information.....	16
6.4 Logging In to a Cloud Desktop.....	19
6.5 Logging Out of the Cloud Desktop.....	21
6.6 Changing Your Password.....	23
6.7 Powering Off or Restarting the Terminal.....	24
7 Advanced Management.....	26
7.1 Resetting the Password.....	26
7.2 Setting General Desktop Parameters.....	28
7.3 Checking the Help Information and Providing the Feedback Information.....	29
7.4 Viewing the Related Information.....	30
7.5 Changing Wallpapers.....	31
7.6 Setting the Display Parameters.....	32
7.7 Adjusting the Volume.....	34
7.8 Adjusting the Power Management Policy.....	35
7.9 Setting the Time.....	36
7.10 Restoring Factory Defaults.....	37
7.11 Managing Wi-Fi Networks.....	38
7.12 Setting a Network Agent.....	40
7.13 Diagnosing the Network.....	41
7.14 Connecting to a Bluetooth Device.....	43
7.15 Adjusting the Mouse Pointer Speed.....	45
7.16 Testing the Hardware of a Cloud Terminal.....	45
7.17 Viewing Version Information.....	48

7.18 Updating System Software.....	50
7.19 Checking Terminal Information.....	52
7.20 Contacting ZTE Technical Support.....	54
7.21 Viewing the Last Login Information.....	55
7.22 Set Authentication Mode.....	57
7.23 Changing the Password.....	60
8 Cloud Desktop Operation Guide.....	62
8.1 Cloud Desktop Toolbar.....	62
8.2 Setting General Desktop Parameters.....	63
8.3 Managing Peripherals.....	64
8.4 Checking the Help Information and Proving the Feedback Information.....	66
8.5 Viewing the Privacy Policy.....	67
8.6 Checking the Environment Information.....	68
8.7 Restarting a Cloud Desktop.....	68
9 Recommended Devices.....	70

About This Manual

Purpose

This manual describes the structure, parameters, and common usage of product W106D.

Intended Audience

This manual is intended for:

- Cloud terminal users
- Maintenance engineers

What Is in This Manual



This manual contains the following chapters and appendixes.

Chapter 1, Safety Precautions	Describes the safety precautions for daily use and maintenance of the W106D.
Chapter 2, Overview	Describes the functions and appearance of the W106D product.
Chapter 3, Packing List	This chapter describes the components in the W106D product packaging.
Chapter 4, Connecting Up	Describes the typical application scenarios of the W106D.
Chapter 5, Technical Specification	Describes the technical specifications of the W106D.
Chapter 6, First Use	Describes how to power on the W106D for the first time.
Chapter 7, Advanced Management	Describes the routine maintenance and management operations of the W106D.
Chapter 8, Cloud Desktop Operation Guide	Describes common operations after you log in to the cloud computer desktop through the W106D.
Chapter 9, Recommended Devices	Describes the common compatible devices of the W106D.

Conventions

This manual uses the following conventions.

<i>Italics</i>	Variables in commands. It may also refer to other related manuals and documents.
Bold	Menus, menu options, function names, input fields, option button names, check boxes, drop-down lists, dialog box names, window names, parameters, and commands.

Constant width	Text that you type, program codes, filenames, directory names, and function names.
[]	Optional parameters.
{ }	Mandatory parameters.
	Separates individual parameters in a series of parameters.
	Danger: indicates an imminently hazardous situation. Failure to comply will result in death or serious personal injury.
	Warning: indicates a potentially hazardous situation. Failure to comply can result in death or serious personal injury.
	Caution: indicates a potentially hazardous situation. Failure to comply can result in moderate or minor personal injury.
	Notice: indicates equipment or environment safety information. Failure to comply can result in equipment damage, data loss, equipment performance degradation, environmental contamination, or other unpredictable results.
	Note: provides additional information about a topic.

Chapter 1

Safety Precautions

Abstract

Read the following precautions before using the W106D.

General Precautions

- If you are not professional maintenance personnel, do not open the shell of the W106D to avoid electric shocks.
- Do not remove or reinstall non-USB-connected devices without turning off the power supply.
- To extend the lifetime of the W106D, do not power it on/off frequently, and ensure that it works in a clean and dry environment.
- Pay attention to the heat dissipation during use. Do not put it in a place exposed to direct sunlight or close to the power supply. Do not place any object on the shell.
- Do not spill water or other liquids on the W106D. As this occurs, disconnect it from its power supply immediately.
- During use, connect and place devices as required and ensure that the power supply is turned off.

Safety Precautions

- Make sure that all cables are connected properly before the W106D is turned on.
- The W106D can only be used indoors. Shut down the W106D before removing the power adapter.
- Before cleaning or stopping using the W106D, turn off the power supply and disconnect the power adapter.
- Use the power adapter dedicated to the W106D and use it within the power range marked on the adapter.
- To prevent fire or electric shocks, do not install the W106D near a heat source.
- On rainy and stormy days, disconnect the power adapter and network cables to avoid damaging the W106D or other accidents.

Maintenance Precautions

- Do not place any heavy objects on the W106D. Place the W106D in a firm place.
- Do not block the vents. Store or use the W106D in a ventilated and dry place.
- Do not store or use the W106D in a hot, cold, wet, or dusty place.
- When cleaning the W106D, use a dry towel or slightly wet towel/cloth. Avoid direct contact with water or other liquids.

Repair Precautions

- Do not allow a non-professional to open the shell of the W106D. Otherwise, the service label will be damaged.
- If repair is required, contact the local repair center.
- If a part needs to be replaced, use the part specified by the manufacturer.

RF Exposure Information

The Maximum Permissible Exposure (MPE) level is calculated based on a distance of $d=20$ cm between the device and the human body. To maintain compliance with the RF exposure requirement, a separation distance of 20 cm between the device and the human should be maintained.

Restrictions in the 5 GHz band

According to Article 10(10) of Directive 2014/53/EU, the packaging shows that this radio equipment will be subject to some restrictions when placed on the market in Belgium (BE), Bulgaria (BG), the Czech Republic (CZ), Denmark (DK), Germany (DE), Estonia (EE), Ireland (IE), Greece (EL), Spain (ES), France (FR), Croatia (HR), Italy (IT), Cyprus (CY), Latvia (LV), Lithuania (LT), Luxembourg (LU), Hungary (HU), Malta (MT), Netherlands (NL), Austria (AT), Poland (PL), Portugal (PT), Romania (RO), Slovenia (SI), Slovakia (SK), Finland (FI), Sweden (SE), the United Turkey (TR), Norway (NO), Switzerland (CH), Iceland (IS), and Liechtenstein (LI). The WLAN function for this device is restricted to indoor use only when operating in the 5150 to 5350 MHz frequency range.

EU Declaration of Conformity

Hereby, ZTE Corporation declares that the radio equipment type W106D is in compliance with Radio Equipment Directive (RED) of European Union.

Chapter 2

Overview

Introduction

W106D is a cloud PC that is designed for mobile working.



It supports wireless and wired connectivity, an HDMI display, and USB peripherals. Equipped with ZTE cloud PC solution, W106D offers simplified and efficient work experience.

Glance

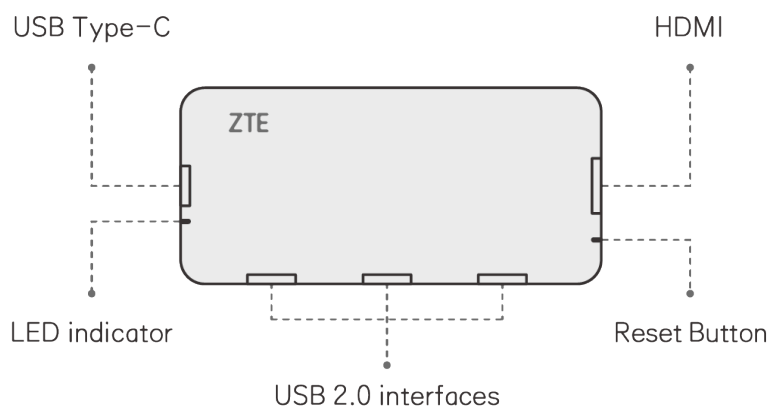
Figure 2-1 Glance



LED indicator Description:

-  Red and steady: booting
-  Green and steady: working
-  Flashing red: upgrading

Chapter 3

Packing List

Item	Quantity
W106D cloud PC	1
Power cable	1
HDMI cable	1
USB NIC	1
Quick guide	1
Safety report	1

Chapter 4

Connecting Up

- Scenario 1

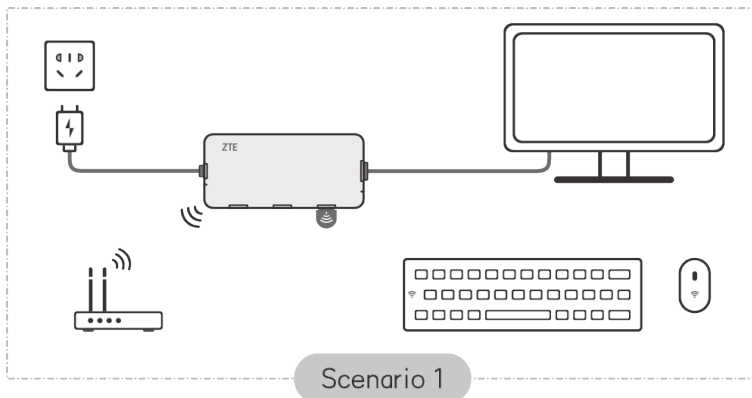

- Scenario 2

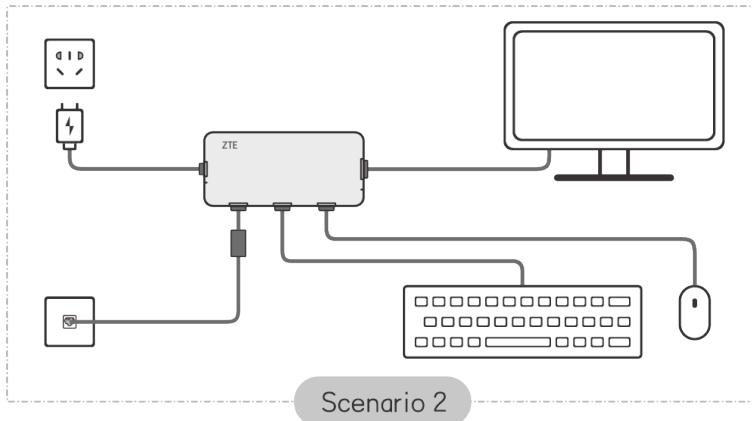

1. Connect W106D to a display with an HDMI cable.
2. Connect a wireless/wired keyboard and mouse to W106D.
3. Connect W106D to a network with a USB to Ethernet adapter.
4. Connect W106D to a power source using the included power adapter. Open the login and settings screen.

Chapter 5

Technical Specification

Dimensions	105.7 mm x 49.5 mm x 10.5 mm (L x W x D)
Weight	55 grams
Interfaces	<ul style="list-style-type: none">● One HDMI interface● Three USB 2.0 interfaces● One USB Type-C interface
Power supply	Auxiliary power adapter. <ul style="list-style-type: none">● Certified by international standards.● Input: 100 V-240 V AC, 50 Hz-60 Hz.● Recommended output voltage: 5 V DC, current: ≥2.0 A.
Operating environment	<ul style="list-style-type: none">● Temperature: 0 °C-40 °C● Relative humidity 5%-95% (non-condensing)
Storage environment	<ul style="list-style-type: none">● Temperature: -15 °C-45 °C● Relative humidity: 20%-85%
Radio Frequency Transmitting Range	<ul style="list-style-type: none">● BT: 2.4 GHz-2.4835 GHz● 2.4G: 2.4 GHz-2.4835 GHz● 5G: 5.15 GHz-5.35 GHz, 5.5 GHz-5.7 GHz, 5.725 GHz-5.85 GHz
Maximum Output Power	≤ 20 dBm

Chapter 6

First Use

Table of Contents

Powering On the Terminal for the First Time.....	7
Network Connection.....	10
(Optional) Setting the Cloud Server Information.....	16
Logging In to a Cloud Desktop.....	19
Logging Out of the Cloud Desktop.....	21
Changing Your Password.....	23
Powering Off or Restarting the Terminal.....	24

6.1 Powering On the Terminal for the First Time

Abstract

To use the W106D, you first need to connect it to the power supply. After the terminal is started, the login screen of the cloud desktop is displayed.

Prerequisite

The terminal is already connected to a wired network through a USB to Ethernet adapter.

Steps

1. Connect the terminal to a keyboard, mouse, display device, wired network, and power supply. Enter the login screen of the cloud desktop.
If you log in to the cloud desktop for the first time, the **Privacy Policy** dialog box is displayed on the login screen, see [Figure 6-1](#).

Figure 6-1 Privacy Policy Dialog Box

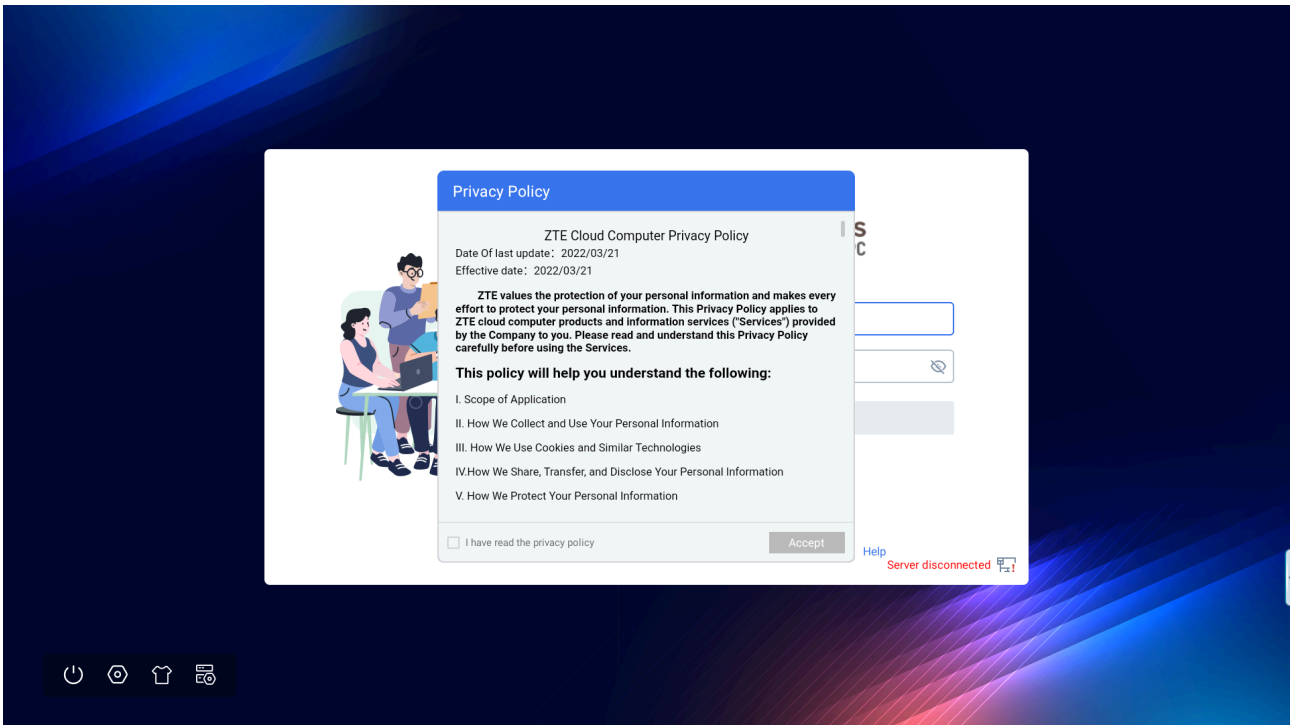

2. After viewing the privacy policy, select **I have read the privacy policy** and click **Accept**. The login management screen is displayed, see [Figure 6-2](#).

Figure 6-2 Login Management Screen

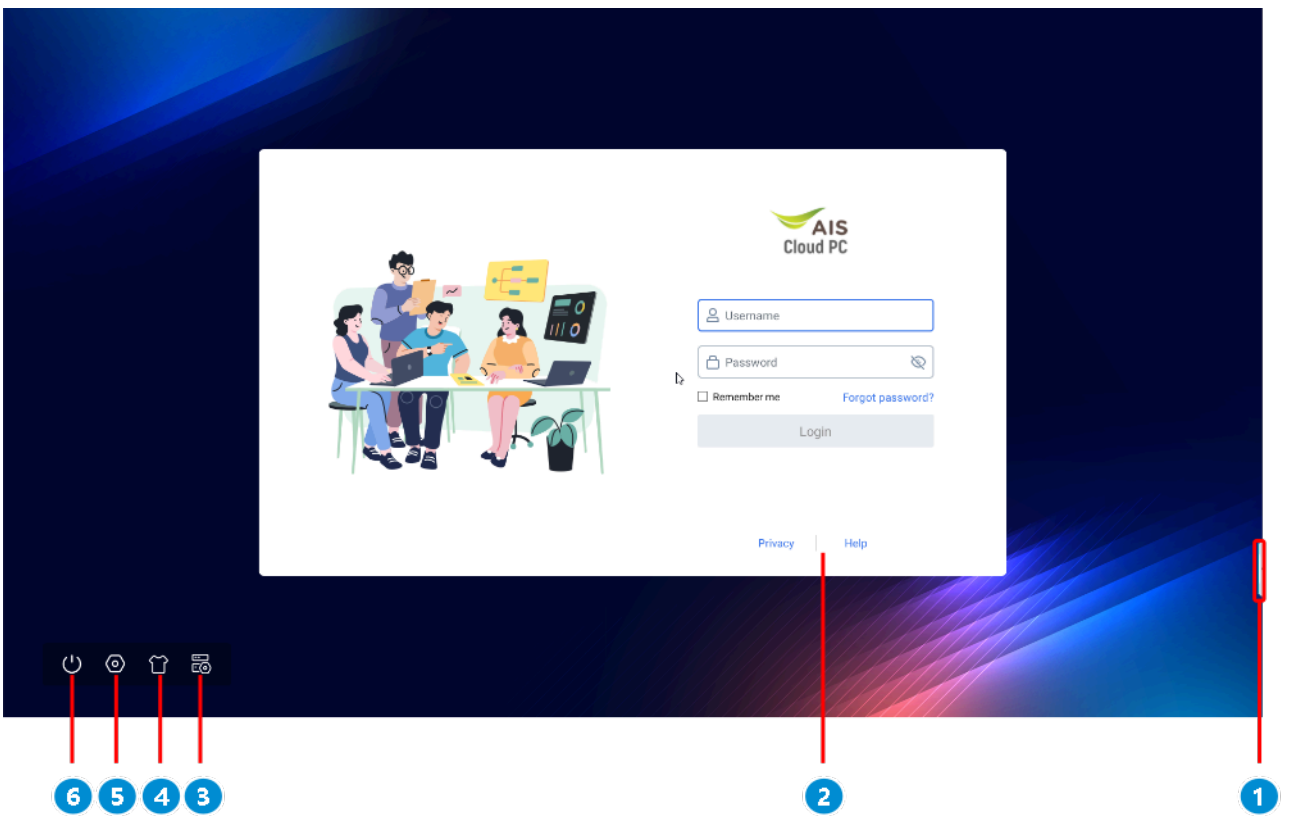

No.	Name	Description
1	Console	Click Console . The floating toolbox of the console is displayed.
2	Login area	You can enter the username and password to log in to the cloud desktop. Note: In the login area, you can view the help and privacy policy information or to retrieve your password by forgetting your password.
3	Cloud server	Click Cloud server to set the server information and login parameters for the cloud desktop.
4	Wallpaper	Click Wallpaper to change the background image of the login management screen.
5	Desktop settings	Click Desktop settings to configure general settings for the terminal.
6	Power	Click Power to shut down or restart the terminal.

3. (Optional) Click **Console**. The floating toolbox of the console is displayed, see [Figure 6-3](#).

Figure 6-3 Floating Toolbox of the Console

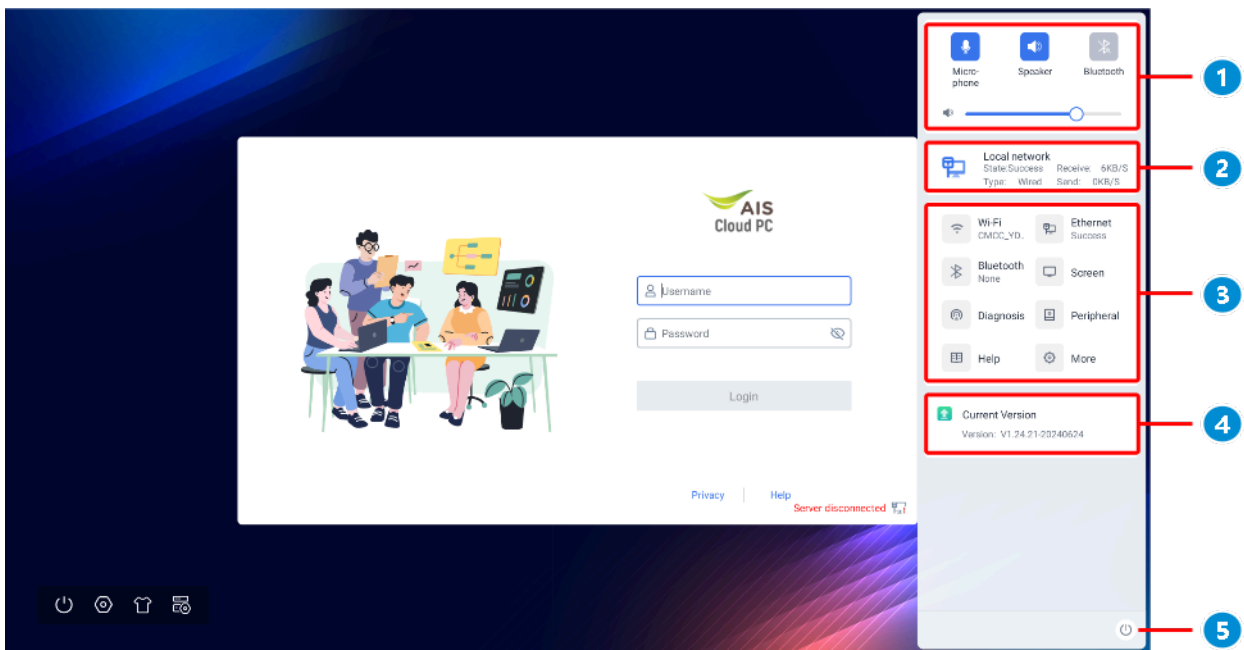

No.	Name	Description
1	Device on/off area	Click Microphone , Speaker , Bluetooth , or another device to enable or disable it. Drag the slider rightward or leftward to adjust the output volume.

No.	Name	Description
2	Local network area	You can view the current network type and status of the terminal.
3	General setting area	Click a module to set it. Modules include Wi-Fi , Ethernet , Bluetooth , Screen , Diagnosis , Peripheral , and Help . Note: You can click More to configure the settings.
4	Version information area	View the version number of the current software of the terminal. Note: To check for terminal updates, you can click Check Update .
5	Power	Click Power to shut down or restart the terminal.

6.2 Network Connection

Before logging in to the cloud desktop from the terminal, you need to connect the terminal to a wired or wireless network as required.

6.2.1 Connecting to a Wired Network

Abstract

Before logging in to the cloud desktop through a wired network that the terminal is connected to, you must configure the corresponding settings.

Note

By default, **Obtain IP Address Automatically** is enabled. The terminal automatically obtains an IP address.

Note

Click **Console**. In the floating toolbox of the console, click **Ethernet**. The **Network/Ethernet** window is displayed, see [Figure 6-6](#).

Note

The IPv4 address configuration is used as an example. For how to configure the IPv6, refer to.

Prerequisites

A wired network is already connected.

Steps

1. In the floating toolbox of the console, click **More**. The window for settings is displayed, see [Figure 6-4](#).

Figure 6-4 Window for Settings

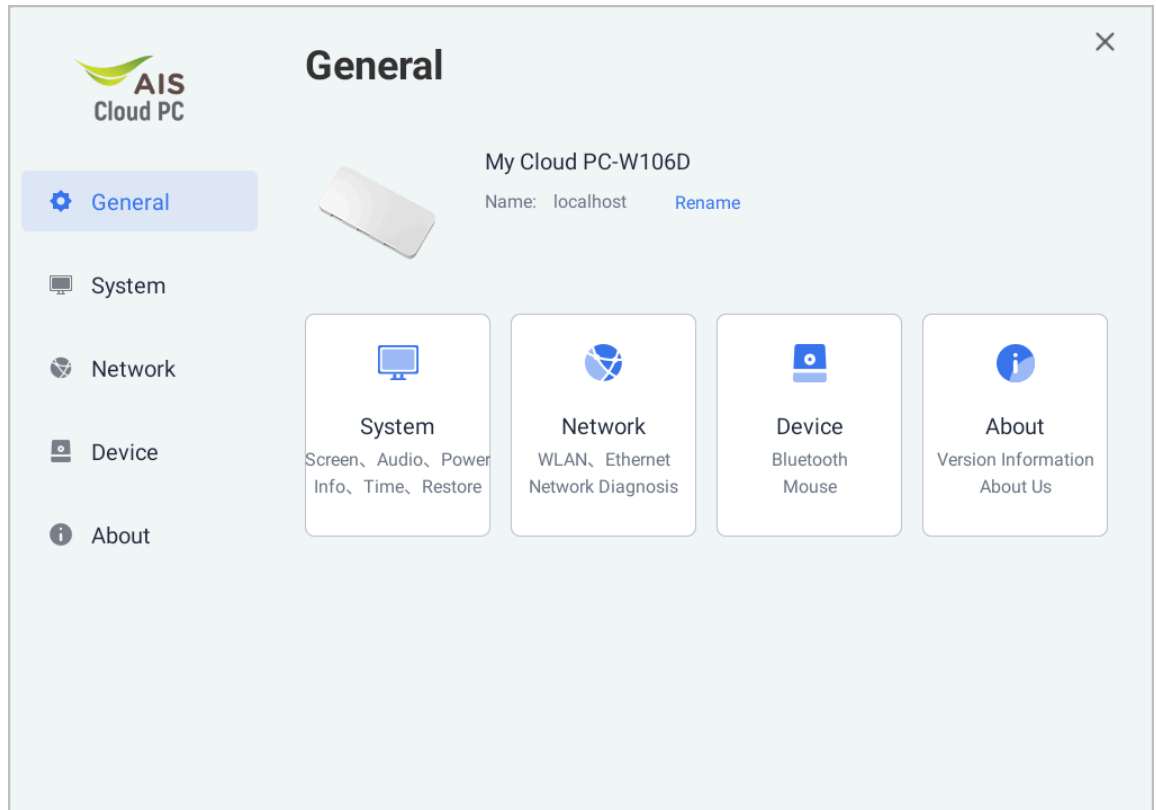

2. Select **Network**. The **Network** window is displayed, see [Figure 6-5](#).

Figure 6-5 Network Window

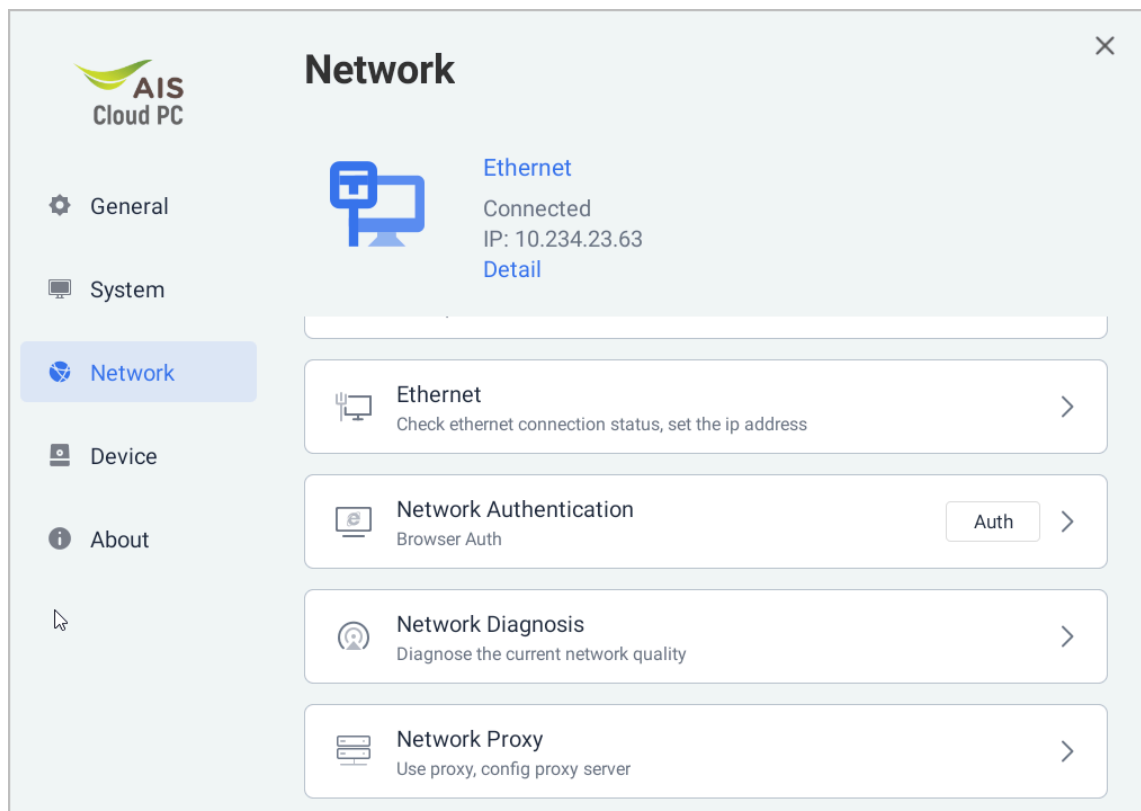

3. Click **Ethernet**. The **Network/Ethernet** window is displayed, see [Figure 6-6](#).

Figure 6-6 Network/Ethernet Window

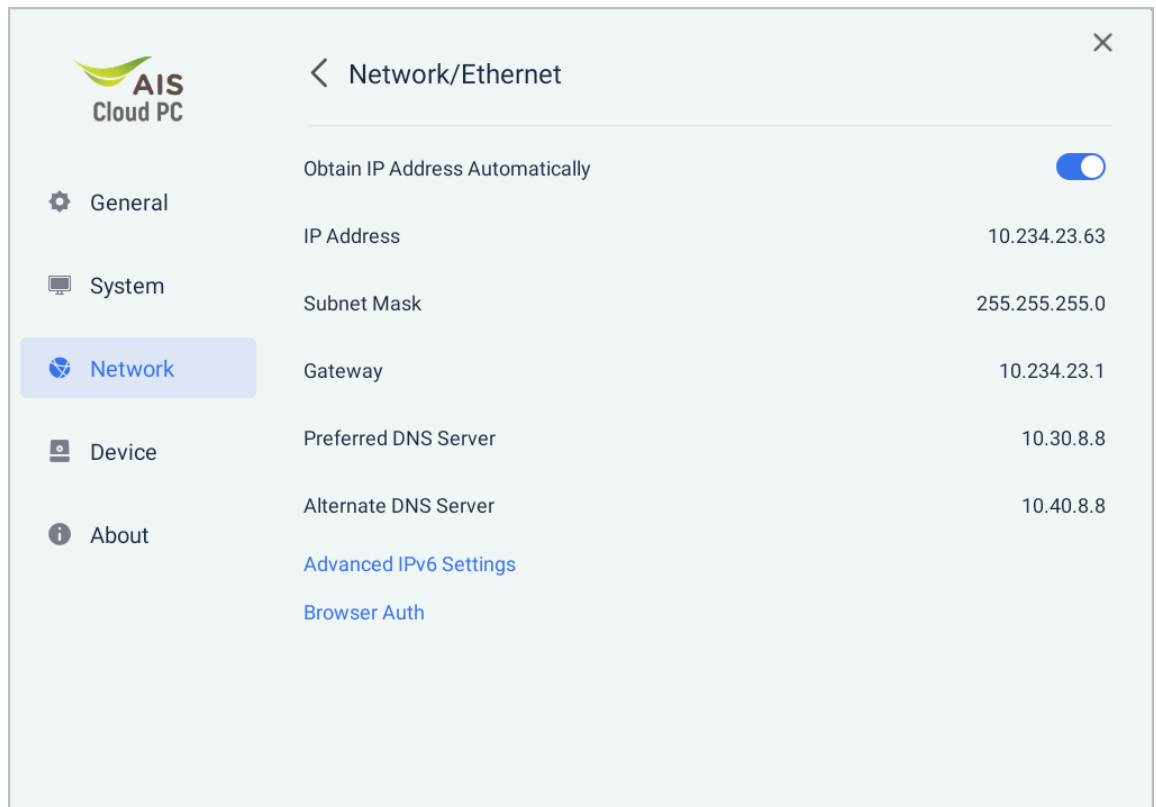

Note

If the router is configured with network authentication, you need to click **Browser Authentication** for network authentication.

4. (Optional) Set the IP address manually.

To set a static IP address, perform the following steps:

- a. Disable **Obtain IP Address Automatically**. The Edit IP Address window is displayed, see [Figure 6-7](#).

Figure 6-7 Edit IP Address Window

The screenshot shows the 'Network/Ethernet' settings window. On the left is a sidebar with options: General, System, Network (selected), Device, and About. The main area contains the following settings:

- Obtain IP Address Automatically:
- IP Address:
- Subnet Mask:
- Gateway:
- Preferred DNS Server:
- Alternate DNS Server:

At the bottom, there are links for 'Advanced IPv6 Settings' and 'Browser Auth', and a blue 'Submit' button.

- b. Set the network parameters as planned. Click **Submit**.

6.2.2 Connecting to a Wireless Network

Abstract

To log in to the cloud desktop through a wireless network, you need to perform the corresponding settings.

Steps

1. In the floating toolbox of the console, click **More**. The window for settings is displayed.
2. Select **Network**. The **Network** window is displayed.
3. Click **WLAN**. The **Network/WLAN** window is displayed, see [Figure 6-8](#).

Figure 6-8 Network/WLAN Window

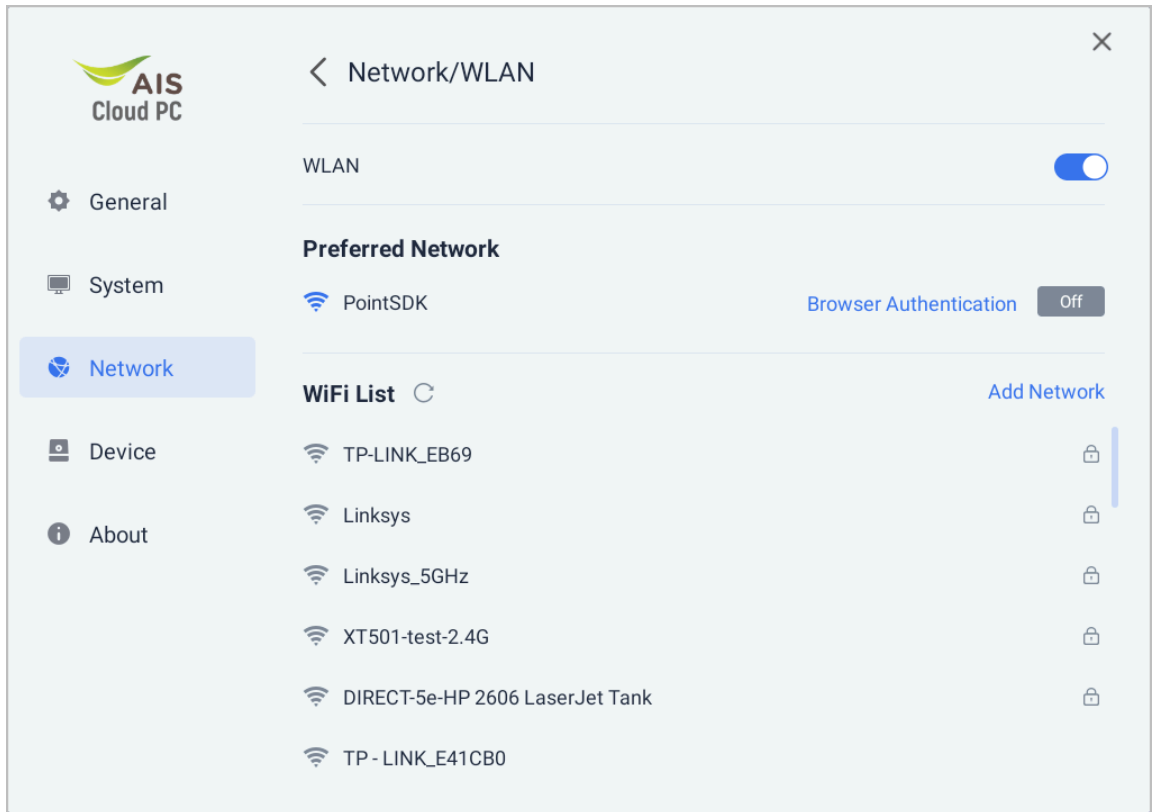

4. Turn **WLAN** on to enable the wireless function.

 **Note**

After the wireless function is enabled, the terminal automatically scans for available wireless networks and displays the discovered wireless networks in **WiFi List**.

5. Perform the following operations for different Wi-Fi networks as required.

To...	Do...
Connect the terminal to a Wi-Fi network for the first time	<ol style="list-style-type: none"> In WiFi List, click the Wi-Fi network to be connected to. The dialog box for entering the password is displayed. Enter the password. Click Connect. After the connection is successful, the Wi-Fi network is displayed in the Preferred Network list, and the system records the password of the Wi-Fi network.
Connect the terminal to a Wi-Fi network that requires authentication	<ol style="list-style-type: none"> In WiFi List, click the Wi-Fi network to be connected to. The dialog box for entering the password is displayed. Enter the Wi-Fi network access password, and click Add. If the password is correct, the authentication page is displayed on the browser.

To...	Do...
	<p>c. Enter the username and password for authentication. If the authentication is successful, the terminal is connected to the Wi-Fi network.</p> <p>Note: If the authentication page is not displayed on the browser, you can manually trigger it. For details, refer to 7.13 Diagnosing the Network.</p>

Related Tasks

For the Wi-Fi networks that are successfully connected to, you can perform the following operations as required.

To...	Do...
Connect the terminal to a Wi-Fi network that was once successfully connected to	<ol style="list-style-type: none"> 1. Click Console. The floating toolbox of the console is displayed. 2. Select Wi-Fi. The WLAN dialog box is displayed. 3. Turn WLAN on to enable the wireless function. 4. In the Preferred Network area, click Connect for the desired Wi-Fi network.
Delete a Wi-Fi network that was once successfully connected to	<ol style="list-style-type: none"> 1. Click Console. The floating toolbox of the console is displayed. 2. Select Wi-Fi. The WLAN dialog box is displayed. 3. In the Preferred Network area, click the desired Wi-Fi network, whether connected to or disconnected from. The Forget button is displayed. 4. Click the Forget button. The Wi-Fi network is ignored and removed from the preferred network list.

6.3 (Optional) Setting the Cloud Server Information

Abstract

This procedure describes how to set the cloud server information, including the login mode, server name, and server address.

Prerequisites

You have obtained the cloud server information from the administrator.

Context

For a description of the server login modes and application scenarios, refer to [Table 6-1](#).

Table 6-1 Login Mode Descriptions

Login Mode	Application Scenario
Intranet	The IP address of the cloud server is an internal network IP address. You log in to the cloud desktop from the internal network.
Internet	The IP address of the cloud server is a public network IP address. You log in to the cloud desktop from the public network.
Automatic	The IP address of the cloud server is an internal network IP address. You log in to the cloud desktop from the public network. Note: You need to set a gateway for the public network IP address.

Steps

1. On the login management screen, click **Cloud server** in the lower right corner. The **Server settings** window is displayed, [Figure 6-9](#).

Figure 6-9 Server Settings Window

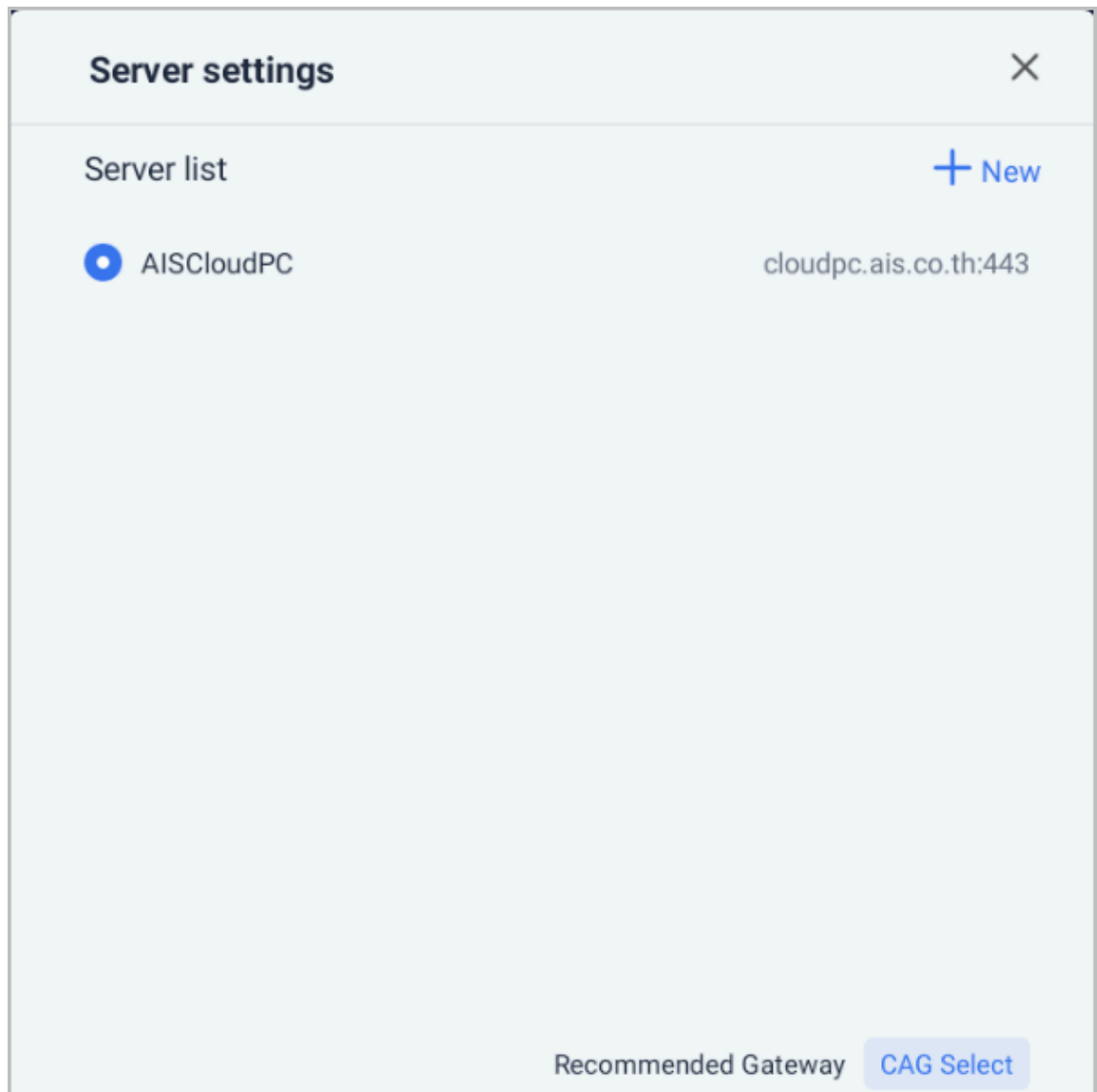

2. (Optional) Add a server as required.
 - a. Click **New**. The **Server list/new** window is displayed, see [Figure 6-10](#).

Figure 6-10 Server List/New Window

Server settings [X]

< Server list/new

Login mode: Automatic

Server Name: Please enter server name

Gateway: Please enter IPV4/[IPV6]/Domain Name:Port

Server address: Please enter IPV4/[IPV6]/Domain Name:Port

Desktop port:

Confirm Cancel

- b. Set the login mode and server parameters, and click **Confirm**.
3. (Optional) Select an optimal gateway as required.
 - a. Click **CAG Select**. The **CAG Select** window is displayed.
 - b. Click **Test** to check the network connection status of all gateways.
 - c. Select an optimal gateway in accordance with the test results.

6.4 Logging In to a Cloud Desktop

Abstract

On the login management screen, enter your username and password to log in to your cloud desktop. After that, you can perform operations on the desktop.

Note

For a description of the cloud desktop toolbar and the operations on the desktop, you can refer to [8 Cloud Desktop Operation Guide](#).

Prerequisites

You have obtained the username and password in advance.

Steps

1. Connect the terminal to a keyboard, mouse, display device, and wired network. After the terminal is powered on, the login management screen is displayed, see [Figure 6-11](#).

Figure 6-11 Login Management Screen

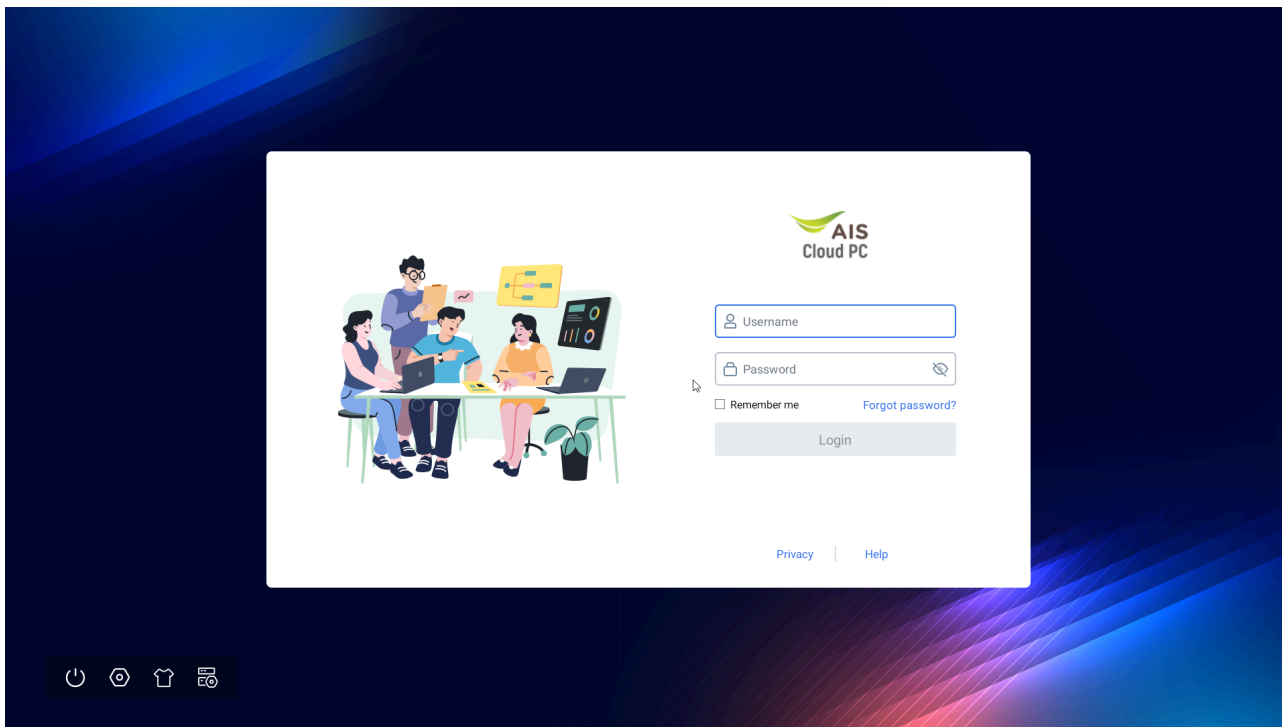

2. Enter your username and password to log in to the cloud desktop. The cloud desktop is displayed, see [Figure 6-12](#).

Figure 6-12 Cloud Desktop

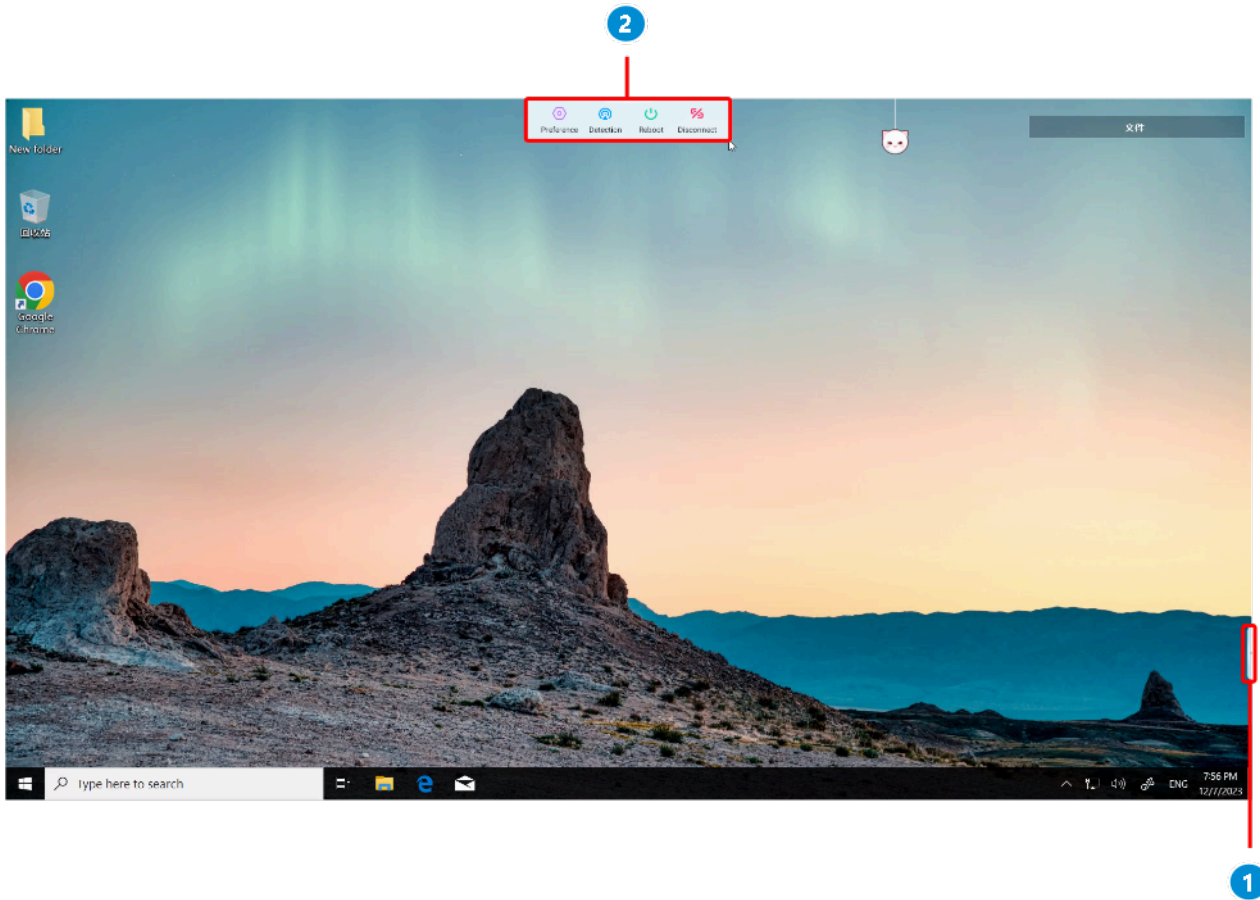

No.	Name	Function Description
1	Cloud desktop toolbar	Move the mouse pointer to the top center of the cloud desktop and click the displayed button. The cloud desktop toolbar is automatically unfolded. For a description of the buttons, refer to 8.1 Cloud Desktop Toolbar .
2	Console button	Click Console . The floating toolbox of the console is displayed. For a description of the icons, refer to Figure 6-3 .

6.5 Logging Out of the Cloud Desktop

Abstract

This procedure describes how to disconnect the terminal from the cloud desktop. The cloud desktop list screen is displayed.

Note

The cloud desktop list screen displays all your cloud desktops and the home server information of each cloud desktop.

Steps

1. After logging in to the cloud desktop, move the mouse pointer to the center of the top of the cloud desktop list screen. The cloud desktop toolbar is displayed automatically.
2. Click **Disconnect** to disconnect the terminal from the cloud desktop. The cloud desktop list screen is displayed, see [Figure 6-13](#).

Figure 6-13 Cloud Desktop List Screen

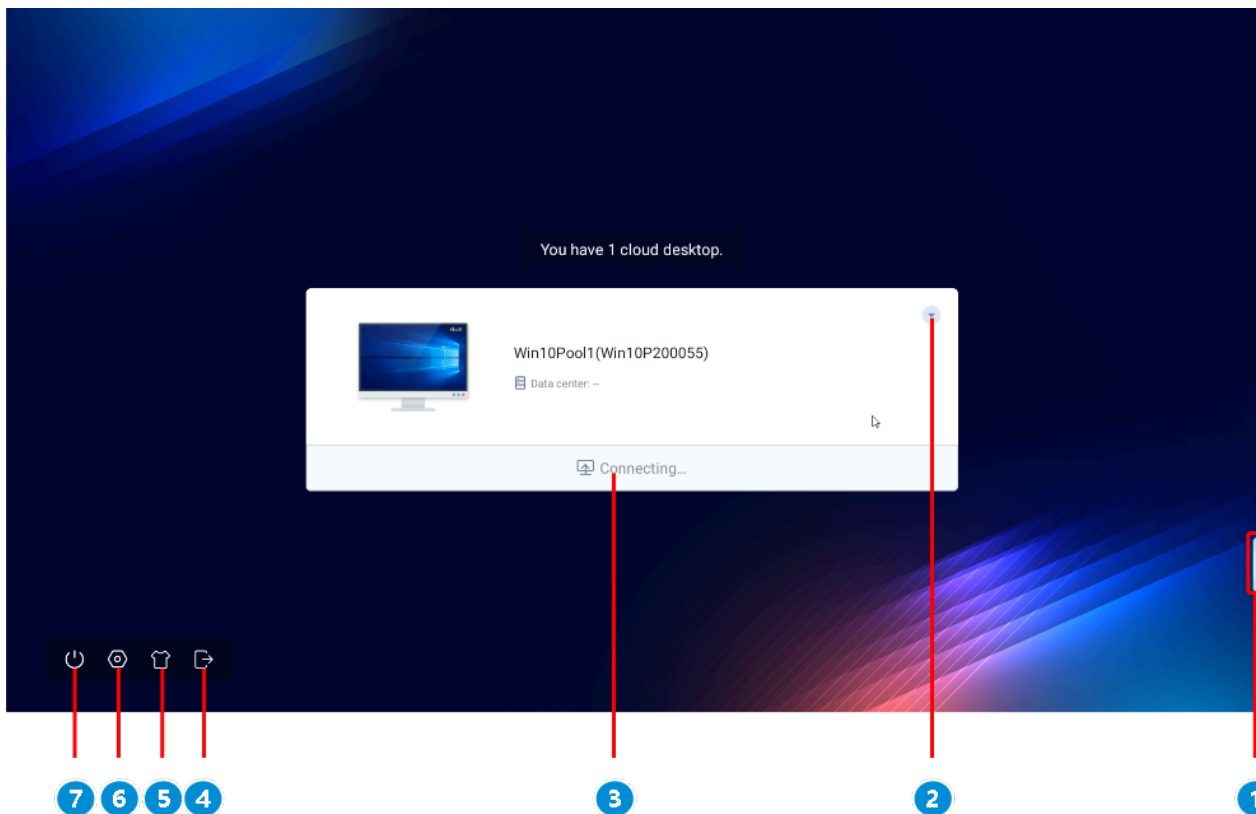

No.	Name	Description
1	Console button	Click Console . The floating toolbox of the console is displayed.
2	Restart	Click Restart to forcibly restart or power off the cloud desktop.
3	Enter desktop	Click Enter desktop to enter the corresponding cloud desktop.
4	Exit	Click Exit to return to the login management screen.
5	Wallpaper	Click Wallpaper to change the background image of the cloud desktop list screen.
6	Desktop settings	Click Desktop settings to enter the Desktop settings window. For details, refer to 8.2 Setting General Desktop Parameters and 6.6 Changing Your Password .

No.	Name	Description
7	Power	Click Power to power off or restart the terminal.

3. Click **Exit** to return to the login management screen.

6.6 Changing Your Password

Abstract

To ensure account security, it is recommended that you modify the account password regularly.

Steps

1. On the cloud desktop list screen, click **Desktop settings**. The **Desktop Settings** window is displayed.
2. Select **Account**. The **Account** window is displayed, see [Figure 6-14](#).

Figure 6-14 Account Window

The screenshot shows the 'Desktop settings' window with the 'Account' section selected. The account name is 'chen004'. There are three password input fields: 'Current' (placeholder: 'Enter current password'), 'New' (placeholder: 'Enter new password'), and 'Confirm' (placeholder: 'Enter new password again'). Below the input fields is a note: 'The password is composed of 3 randomly: capital letters, lowercase letters, numbers and special characters'. At the bottom, there are 'Save' and 'Clear' buttons.

3. Enter the current password, new password and confirm the new password in the **Current**, **New**, and **Confirm** text boxes, respectively, and click **Save**.

6.7 Powering Off or Restarting the Terminal

Abstract

This procedure describes how to power off or restart the terminal on the login management screen.

Note

This procedure uses the **Power** button on the floating toolbox of the console as an example. The operations and functions of the **Power** button on other GUIs are the same.

Steps

1. On the login management screen, click **Console**. The floating toolbox of the console is displayed.
2. Click **Power**. The screen for terminal power-off or restart is displayed, see [Figure 6-15](#).

Figure 6-15 Powering Off or Restarting the Terminal

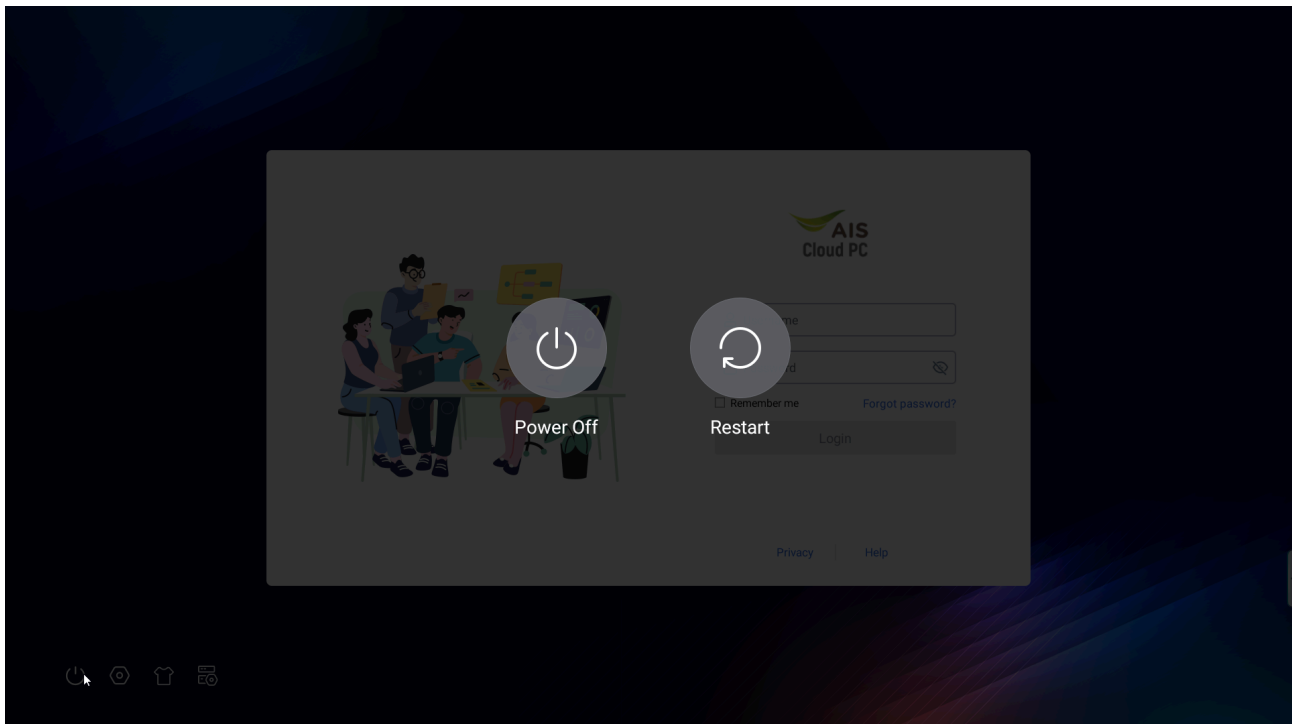

Note

Click the blank area to cancel the power-off or restart operation.

3. Perform the following operations as needed.

To...	Do...
Power off the terminal	Click Power Off . Note: After the terminal is powered off, it is recommended that you disconnect the power supply. After the terminal is powered on again, the login management screen is displayed.
Restart the terminal	Click Restart .

Chapter 7

Advanced Management

Table of Contents

Resetting the Password.....	26
Setting General Desktop Parameters.....	28
Checking the Help Information and Providing the Feedback Information.....	29
Viewing the Related Information.....	30
Changing Wallpapers.....	31
Setting the Display Parameters.....	32
Adjusting the Volume.....	34
Adjusting the Power Management Policy.....	35
Setting the Time.....	36
Restoring Factory Defaults.....	37
Managing Wi-Fi Networks.....	38
Setting a Network Agent.....	40
Diagnosing the Network.....	41
Connecting to a Bluetooth Device.....	43
Adjusting the Mouse Pointer Speed.....	45
Testing the Hardware of a Cloud Terminal.....	45
Viewing Version Information.....	48
Updating System Software.....	50
Checking Terminal Information.....	52
Contacting ZTE Technical Support.....	54
Viewing the Last Login Information.....	55
Set Authentication Mode.....	57
Changing the Password.....	60

7.1 Resetting the Password

Abstract

This procedure describes how to reset your password if you forget it.

 **Note**

The password must contain at least three of the following types: uppercase letters, lowercase letters, digits, and special characters.

Prerequisite

The account is already bound to a mobile phone number.

Steps

1. On the login management screen, click **Forgot password**. The **Security verification** screen is displayed, see [Figure 7-1](#).

Figure 7-1 Security Verification Screen



Security verification screen interface:

- Back to login page (with arrow icon)
- Security verification
- Information icon: To ensure account security, enter the username and verification code for security verification.
- Username input field
- Verification code input field (with shield icon) and a grey box containing the code 64948H
- Next button
- Privacy | Help links

2. Enter a username and verification code, and click **Next**. The **Reset Password** screen is displayed, see [Figure 7-2](#).

Figure 7-2 Reset Password Screen

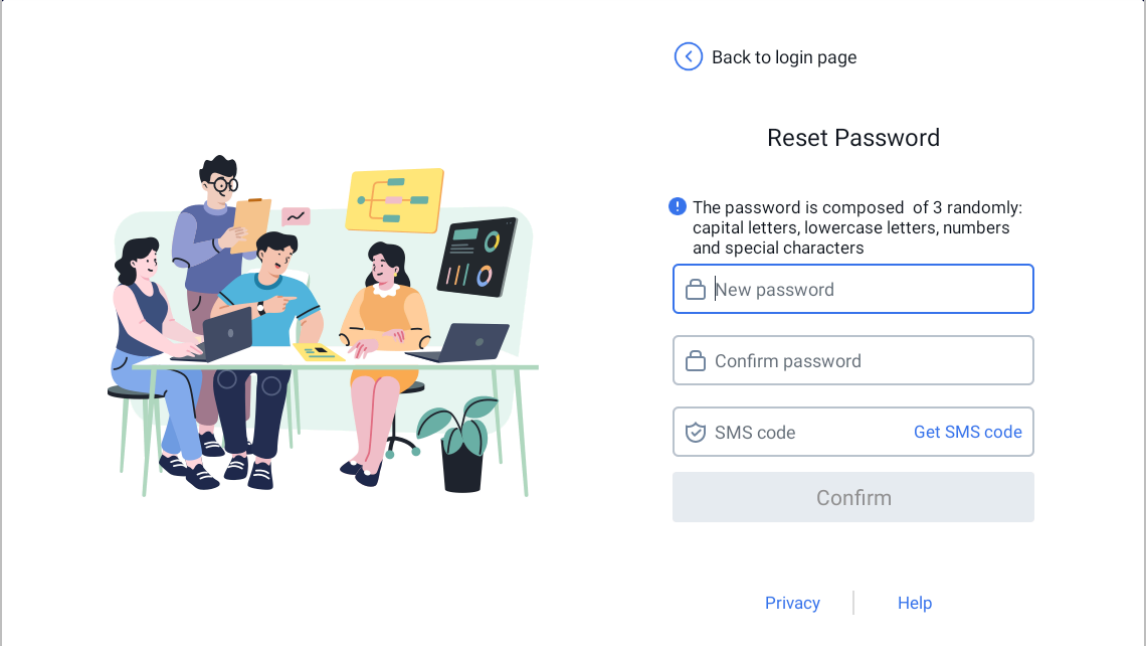

[Back to login page](#)

Reset Password

i The password is composed of 3 randomly: capital letters, lowercase letters, numbers and special characters

 [Get SMS code](#)[Privacy](#) | [Help](#)

3. Enter the new password twice and click **Get SMS code**.
4. Enter the verification code received by the mobile phone and click **Confirm**. The modification result is displayed.

7.2 Setting General Desktop Parameters

Abstract

This procedure describes how to set general desktop parameters, including the parameters that set whether to automatically enter the cloud desktop upon login and set whether to automatically hide the cloud desktop toolbar if no operation is performed in three seconds.

Steps

1. On the login management screen, click **Desktop settings**. The **Desktop settings** window is displayed, see [Figure 7-3](#).

Figure 7-3 Desktop Settings Window

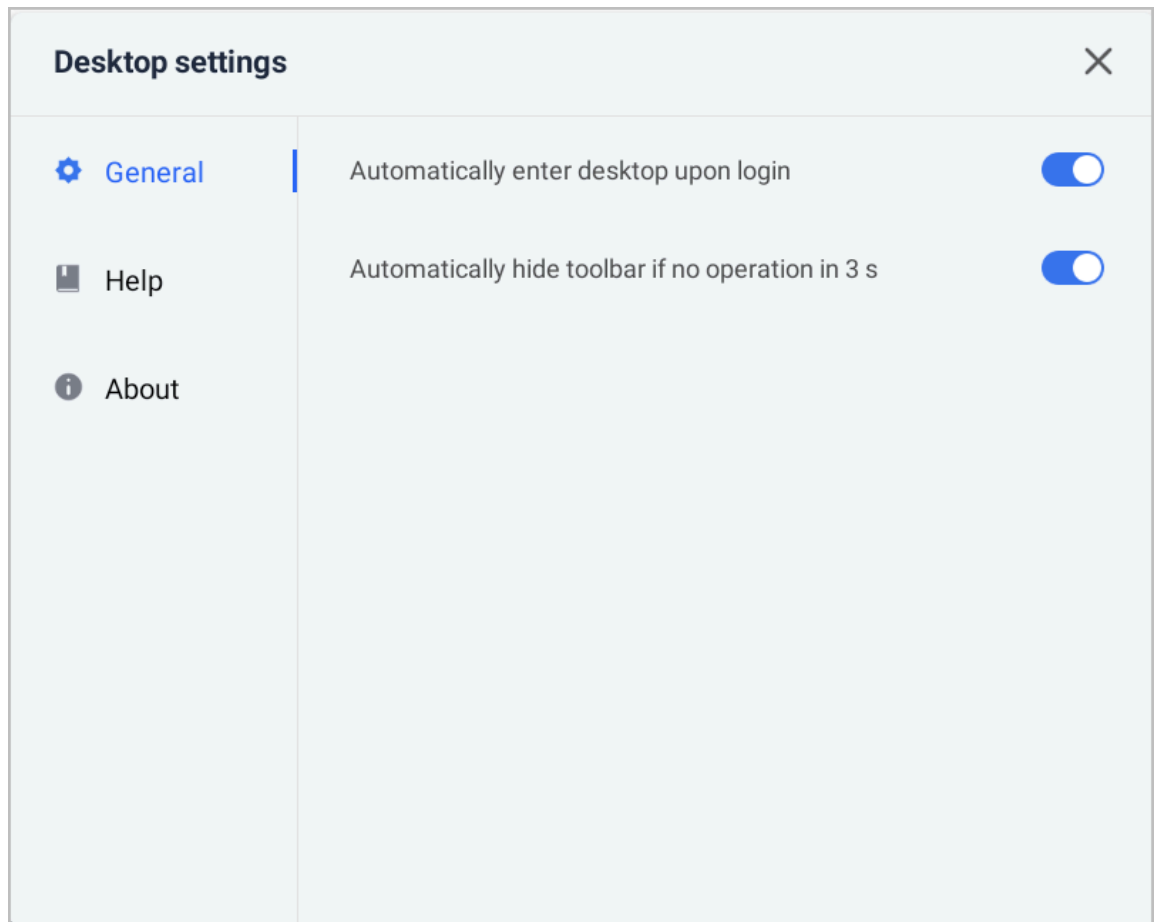

2. Set the parameters as required.

7.3 Checking the Help Information and Providing the Feedback Information

Abstract

In the desktop settings, you can check the help document of the cloud desktop and upload the W106D logs to report faults.

Steps

1. On the log management screen, click **Desktop settings**. The **Desktop settings** window is displayed.
2. Select **Help**. The **Help** window is displayed, see [Figure 7-4](#).

Figure 7-4 Help Window

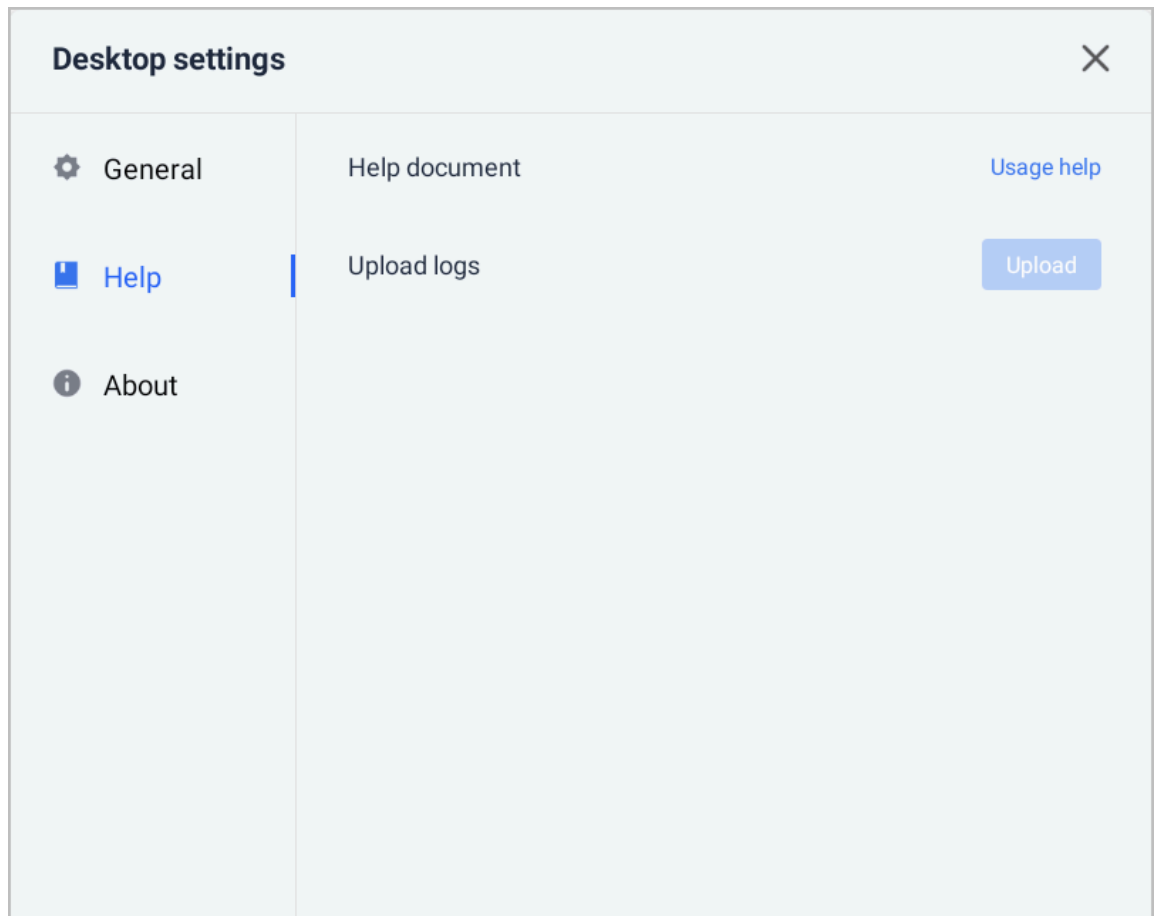

3. Perform the following operations as required.

To...	Do...
Check the help document	Click Usage help .
Upload logs	Click Upload .

7.4 Viewing the Related Information

Abstract

This procedure describes how to view the privacy policy.

Steps

1. On the login management screen, click **Desktop settings**. The **Desktop settings** window is displayed.
2. Select **About**. The **About** window is displayed, see [Figure 7-5](#).

Figure 7-5 About Window

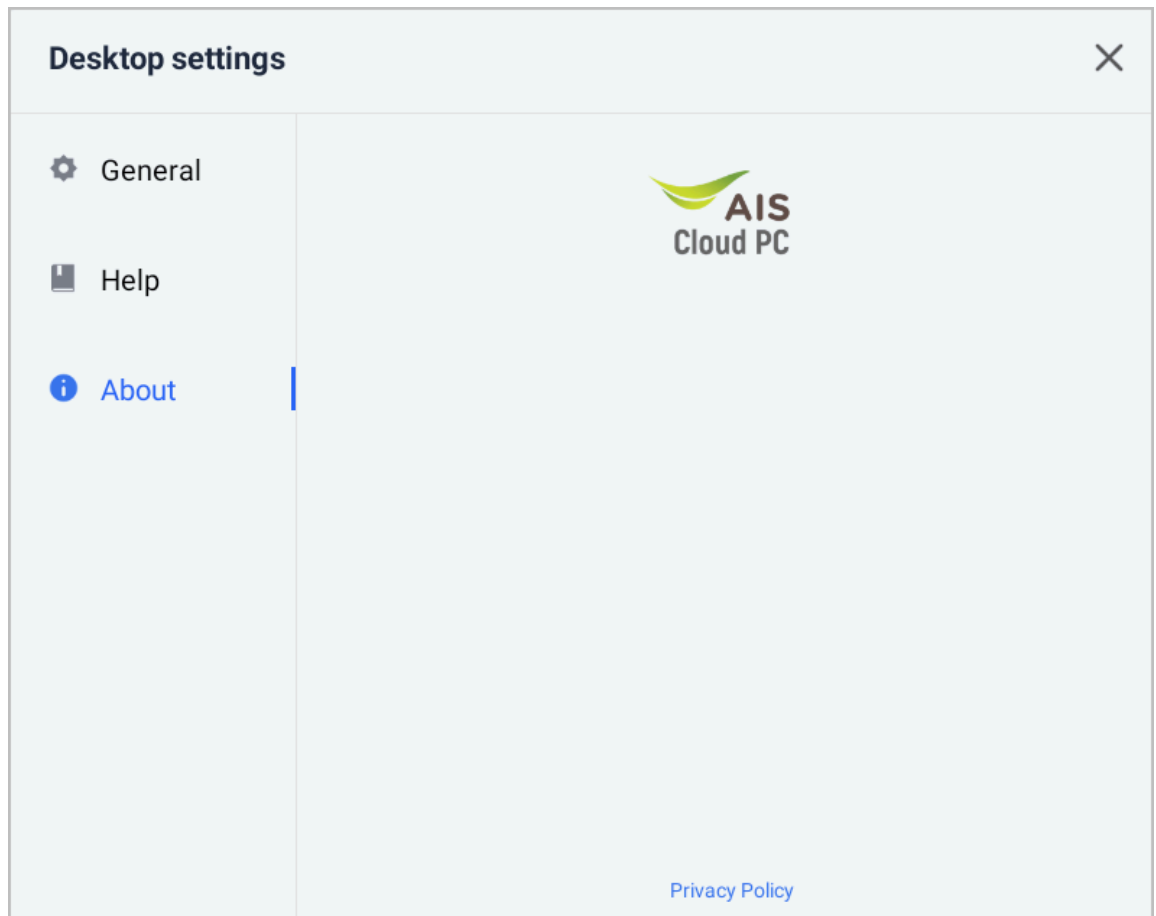

3. Click **Privacy Policy**.

7.5 Changing Wallpapers

Abstract

You can change the background image of the login management screen based on your personal preference.

Steps

1. On the login management screen, click **Wallpaper**. Available wallpapers are displayed.

Figure 7-6 Wallpapers

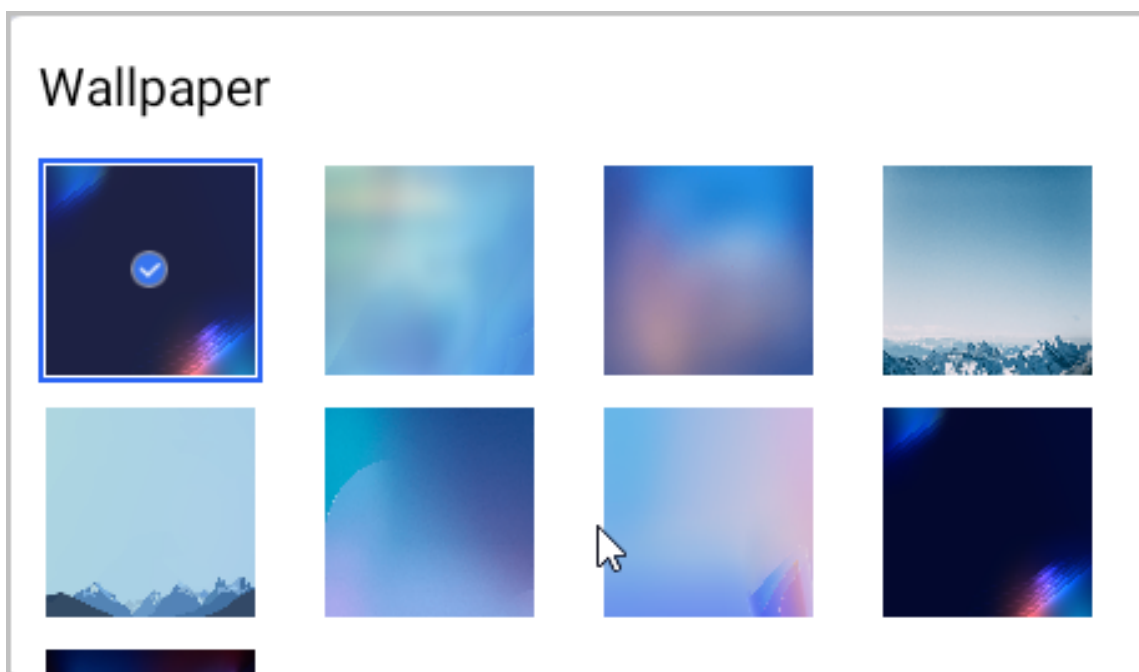

2. Select a wallpaper as the background image of the login management screen.

7.6 Setting the Display Parameters

Abstract

You can set the zoom scale and display resolution and enable image stabilization as required.

Note

You can check the current display resolution in the **System/Display** window.

Steps

1. In the floating toolbox of the console, click **More**. The window for settings is displayed.
2. Select **System**. The **System** window is displayed, see [Figure 7-7](#).

Figure 7-7 System Window

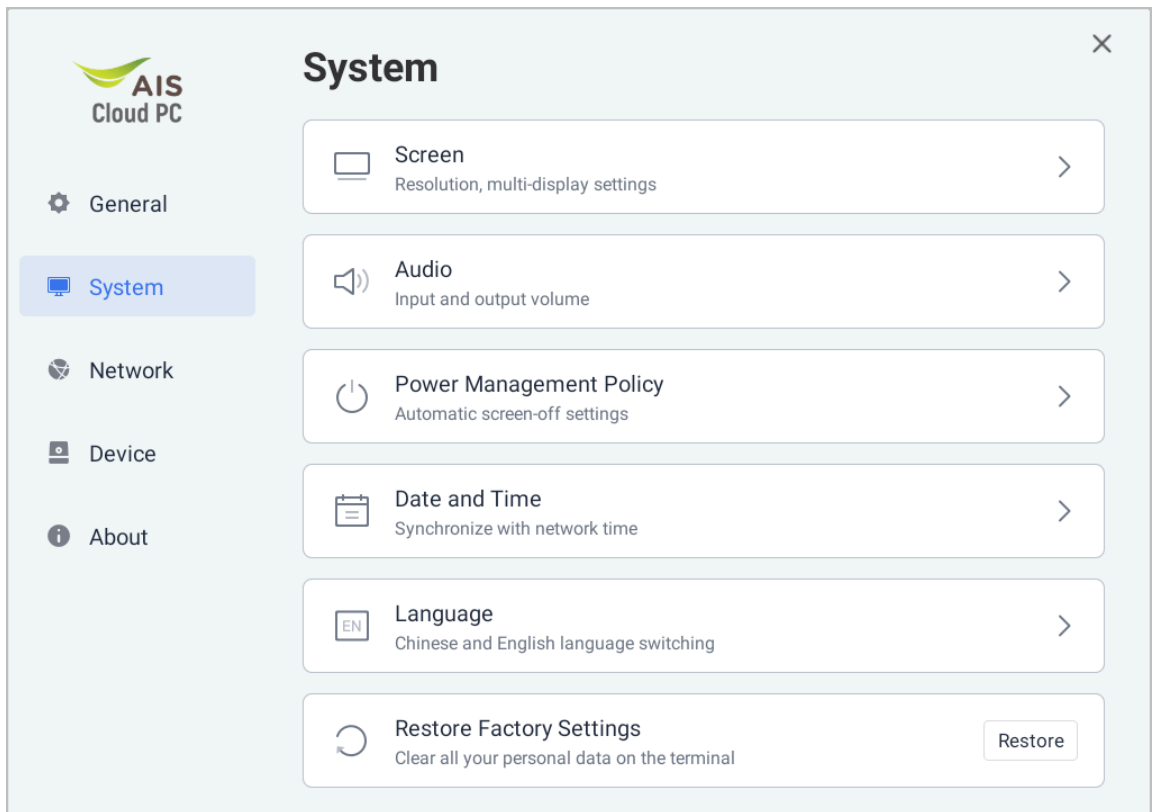

3. Click **Screen**. The **System/Display** window is displayed, see [Figure 7-8](#).

Figure 7-8 System/Display Window

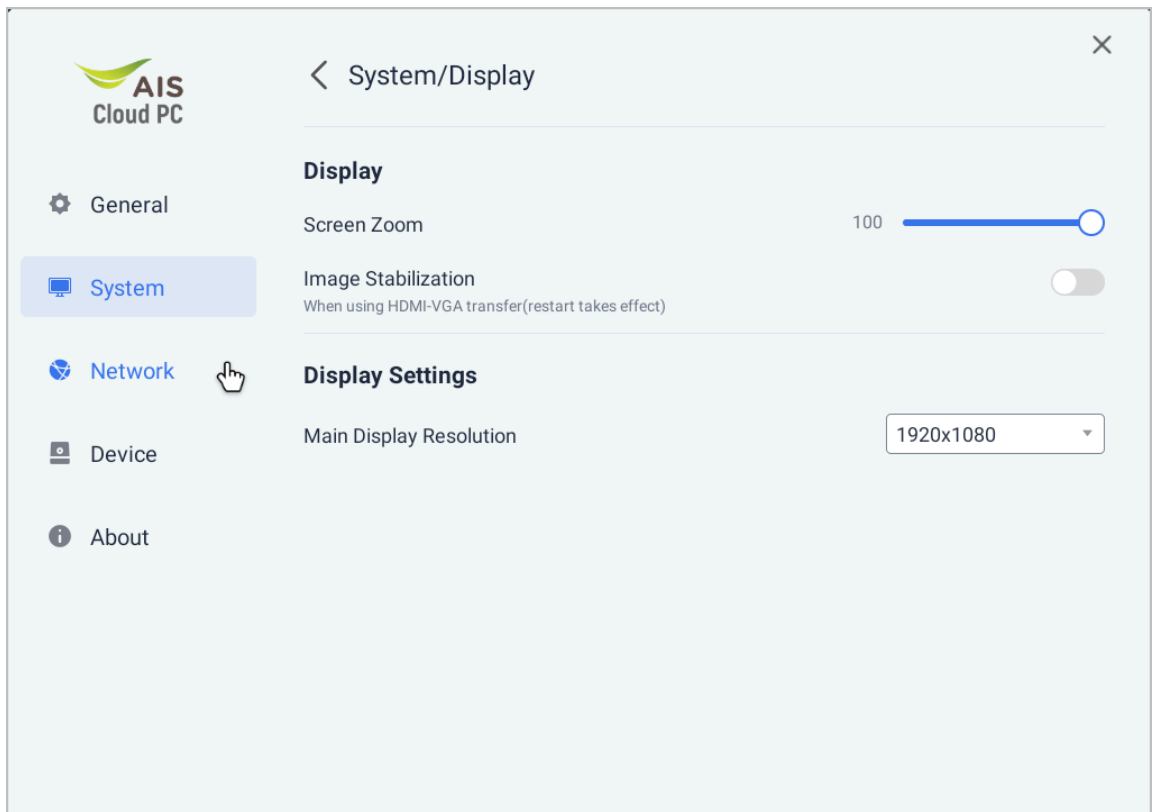

4. Set the display-related parameters as required.

To...	Do...
Set the display resolution	In the Display Settings area, select a value from the Main Display Resolution list.
Set the zoom scale	Drag the Screen Zoom slider to set the display zoom ratio.
Enable image stabilization	Enable Image Stabilization when an HDMI to VAG cable or adapter is used. Note: This function takes effect only after the W106D is restarted.

7.7 Adjusting the Volume

Abstract

This procedure describes how to adjust the input or output volume when using the terminal.

Prerequisites

Audio devices are connected, for example, the earphone, microphone, and speaker.

Steps

1. In the floating toolbox of the console, click **More**. The window for settings is displayed.

2. Select **System**. The **System** window is displayed.
3. Click **Audio**. The **System/Audio** window is displayed, see [Figure 7-9](#).

Figure 7-9 System/Audio Window

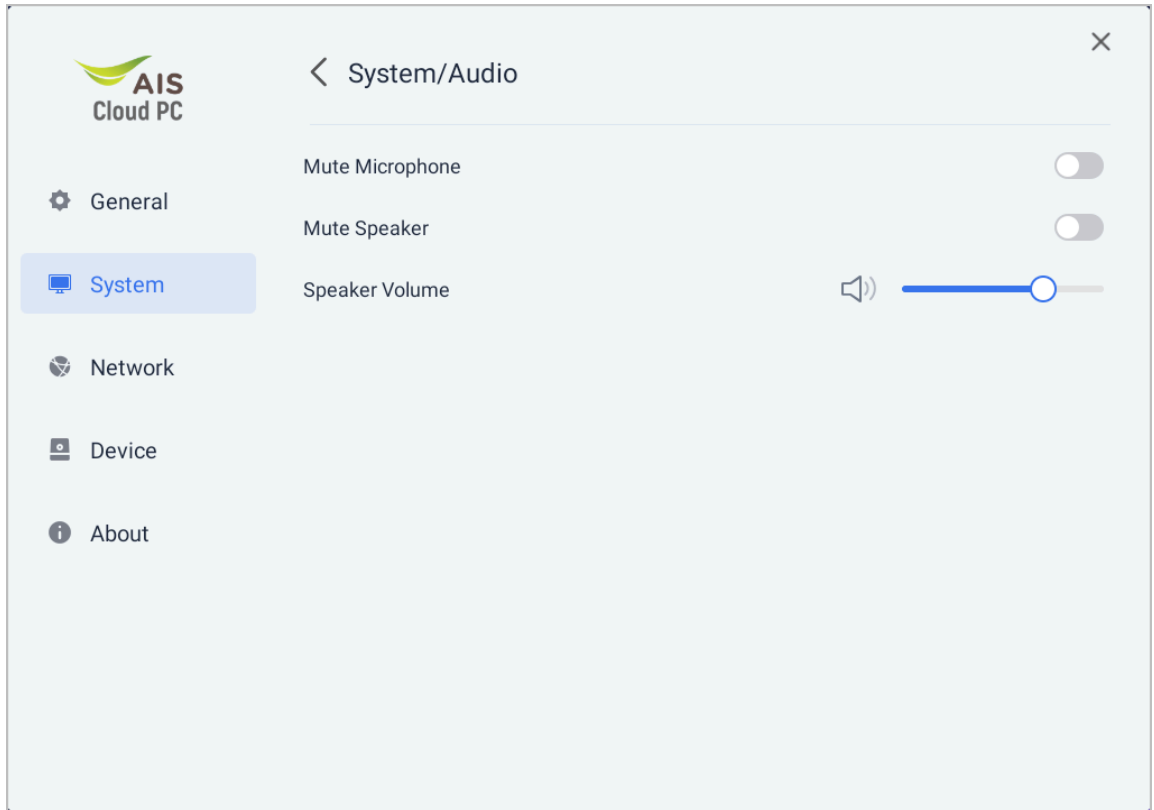

4. Adjust the audio settings as needed.

To...	Do...
Mute/unmute the microphone	Turn Mute Microphone on or off.
Mute/unmute the speaker	Turn Mute Speaker on or off.
Adjust the speaker volume	Drag the slider rightward or leftward to adjust the speaker volume.

7.8 Adjusting the Power Management Policy

Abstract

After the power management strategy is set, if there is no mouse or keyboard operation in the preset duration (for example, 10 minutes), the W106D screen is locked.

Steps

1. In the floating toolbox of the console, click **More**. The window for settings is displayed.
2. Select **System**. The **System** window is displayed.

3. Click **Power Management Policy**. The **System/Power Management Policy** window is displayed, see [Figure 7-10](#).

Figure 7-10 System/Power Management Policy Window

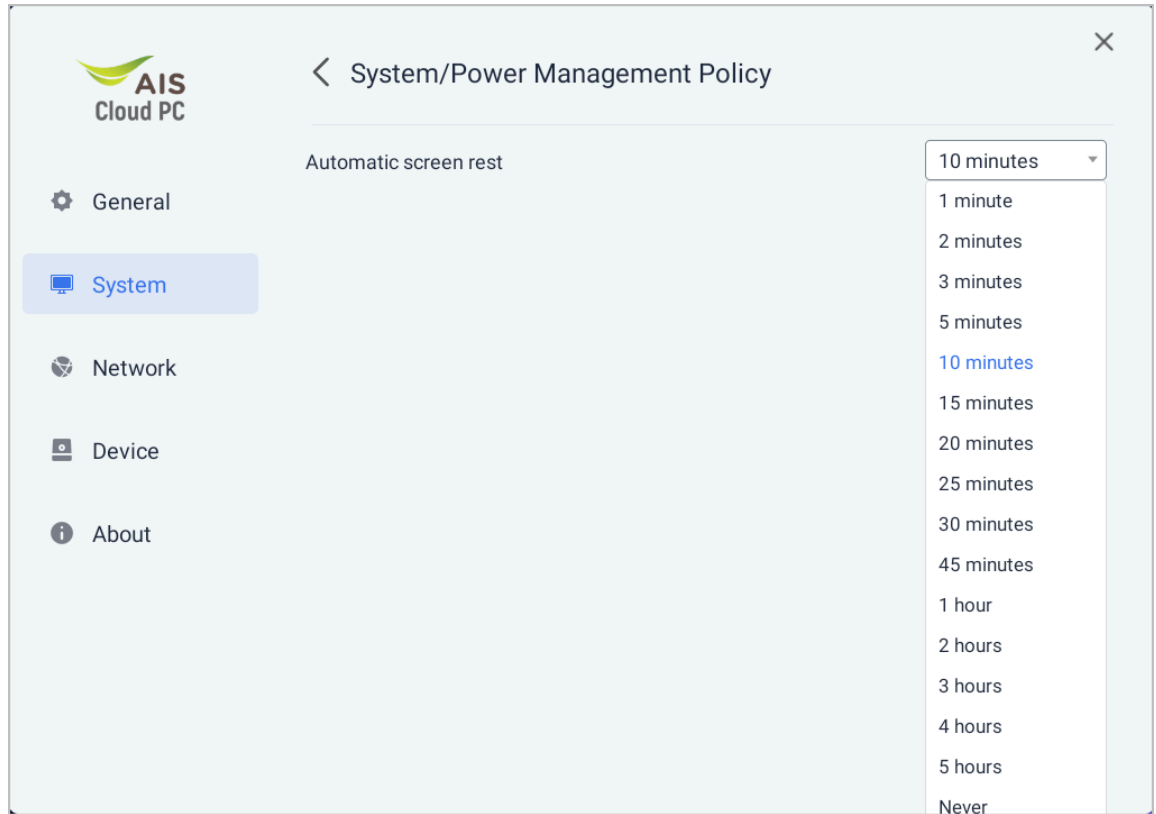

4. Set **Automatic screen rest** (for example, 10 minutes).

7.9 Setting the Time

Abstract

This procedure describes how to adjust the time synchronization server or time for the terminal as needed.

Steps

1. In the floating toolbox of the console, click **More**. The window for settings is displayed.
2. Select **System**. The **System** window is displayed.
3. Click **Date and Time**. The **System/Date and Time** window is displayed, see [Figure 7-11](#).

Figure 7-11 System/Date and Time Window

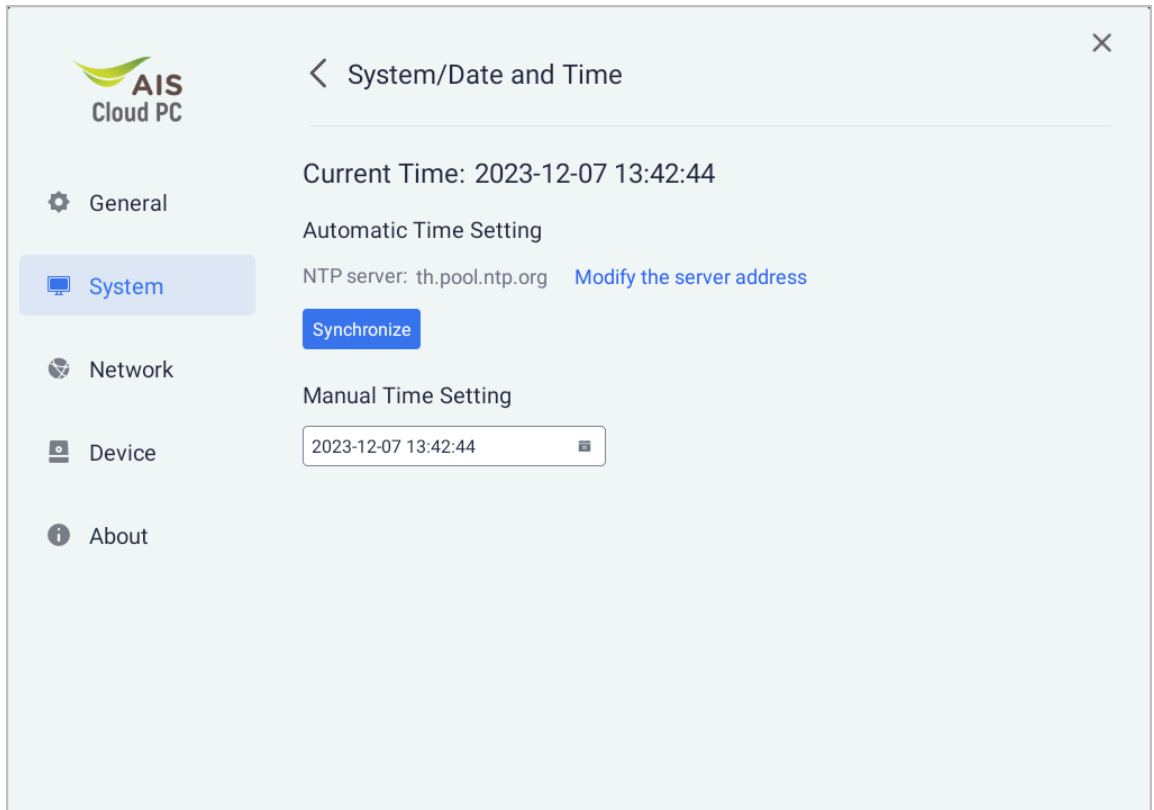

4. Perform the following operations as required.

To...	Do...
Modify the IP address of the time server	a. Click Modify the server address . The dialog box for modifying the server address is displayed. b. Set the IP address of the time server as planned, save the configuration, and exit.
Automatically synchronize the time	Click Synchronize to synchronize time with the time server.
Manually adjust the time	Manually adjust the date and time in the Manual Time Setting area.

7.10 Restoring Factory Defaults

Abstract

If the system of the terminal is faulty, you can recover it by restoring the factory settings.



Notice

After the factory settings are restored, all settings on the terminal are restored to the original settings.

 **Note**

Restoring factory settings restores the settings on the terminal only. Those on the cloud desktops are not affected.

 **Note**

After the restoration is completed, the terminal automatically restarts.

Steps

1. In the floating toolbox of the console, click **More**. The window for settings is displayed.
2. Select **System**. The **System** window is displayed, see [Figure 7-12](#).

Figure 7-12 System Window

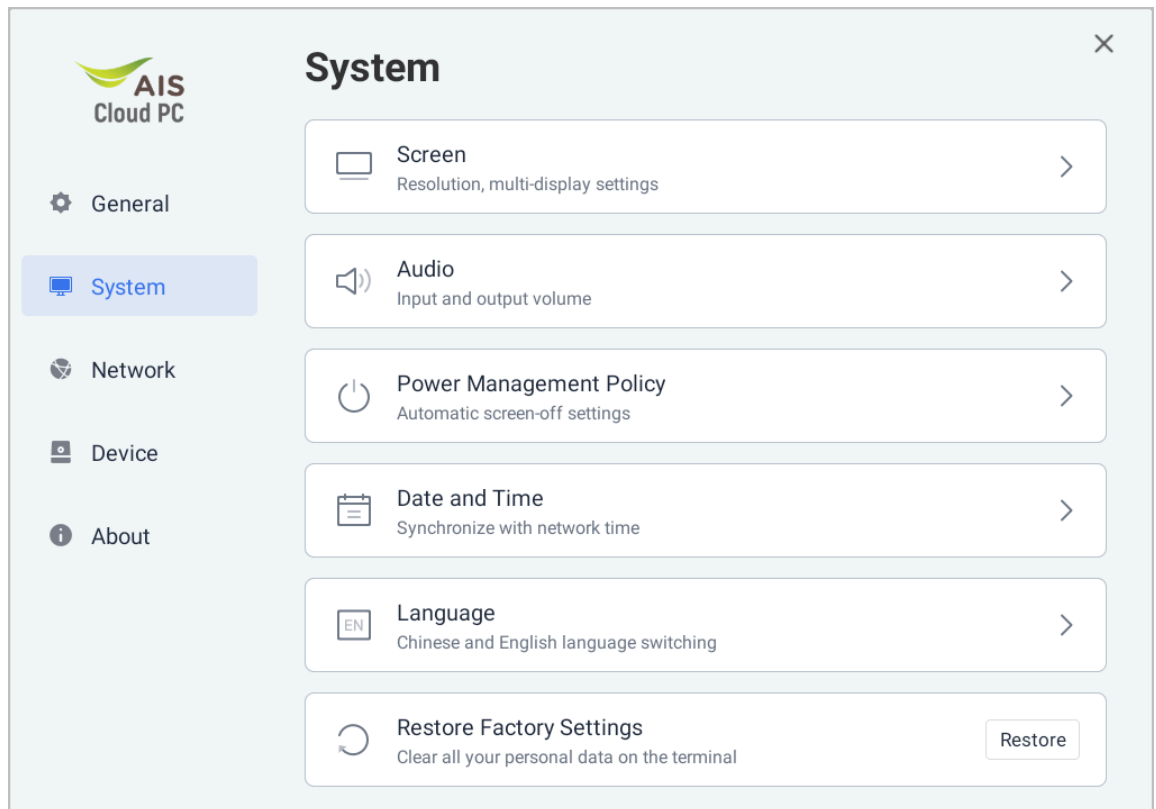

3. Click **Restore** in **Restore Factory Settings**. A confirmation dialog box is displayed.
4. Click **OK**.

7.11 Managing Wi-Fi Networks

Abstract

This procedure describes how to manage known Wi-Fi networks, including deleting a network, disconnecting from a network, and setting a static IP address.

Steps

1. In the floating toolbox of the console, click **More**. The window for settings is displayed.
2. Select **Network**. The **Network** window is displayed.
3. Click **WLAN**. The **Network/WLAN** window is displayed, see [Figure 7-13](#).

Figure 7-13 Network/WLAN Window

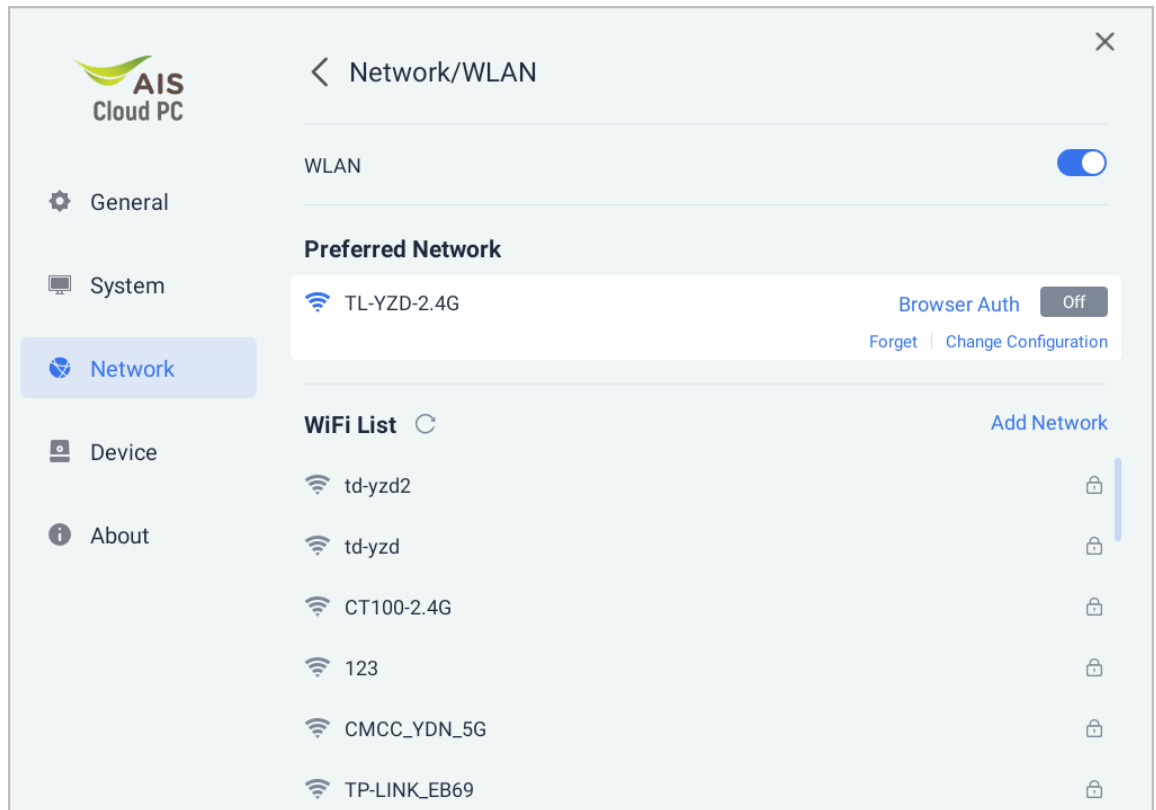

4. Perform the following operations as required.

To...	Do...
Delete a known Wi-Fi network in the Preferred Network area	a. Click Forget to forget and delete the Wi-Fi network.
Modify the configuration of a known Wi-Fi network	a. Click Change Configuration to display the Change Configuration window. b. Disable Obtain IP Address Automatically . c. Set the static IP address of the Wi-Fi network as planned and click OK .
Disconnect from a known Wi-Fi network	a. Click Off to disconnect from the Wi-Fi network.
Connect to a hidden Wi-Fi network	a. Click Add Network next to WiFi List . The Add Network window is displayed. b. Set the network parameters and click Join .

To...	Do...
	Note: For a hidden Wi-Fi network, you need to obtain the network parameters in advance, including Name , Security , and Password .

7.12 Setting a Network Agent

Abstract

This procedure describes how to set a network agent to implement the cross-network access function.

Prerequisite

You have obtained the IP address of the network agent in advance.

Steps

1. In the floating toolbox of the console, click **More**. The window for settings is displayed.
2. Select **Network**. The **Network** window is displayed.
3. Click **Network Proxy**. The **Network/Proxy** window is displayed, see [Figure 7-14](#).

Figure 7-14 Network/Proxy Window

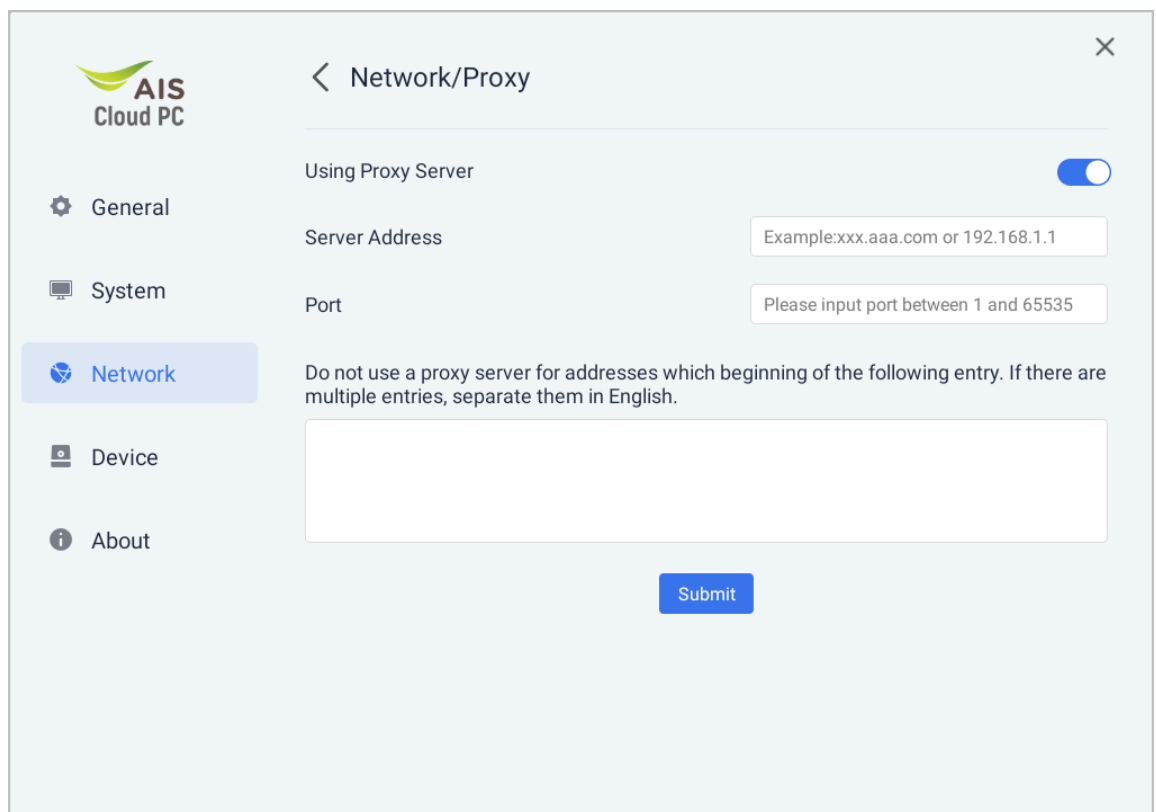

4. Enable **Using Proxy Server**. The network agent–related parameters are displayed.
5. Set the parameters and click **Submit**.

7.13 Diagnosing the Network

Abstract

If you fail to log in to a cloud desktop from the terminal, you can use the network diagnosis function to check the current network status.

Steps

1. In the floating toolbox of the console, click **More**. The window for settings is displayed.
2. Select **Network**. The **Network** window is displayed, see [Figure 7-15](#).

Figure 7-15 Network Window

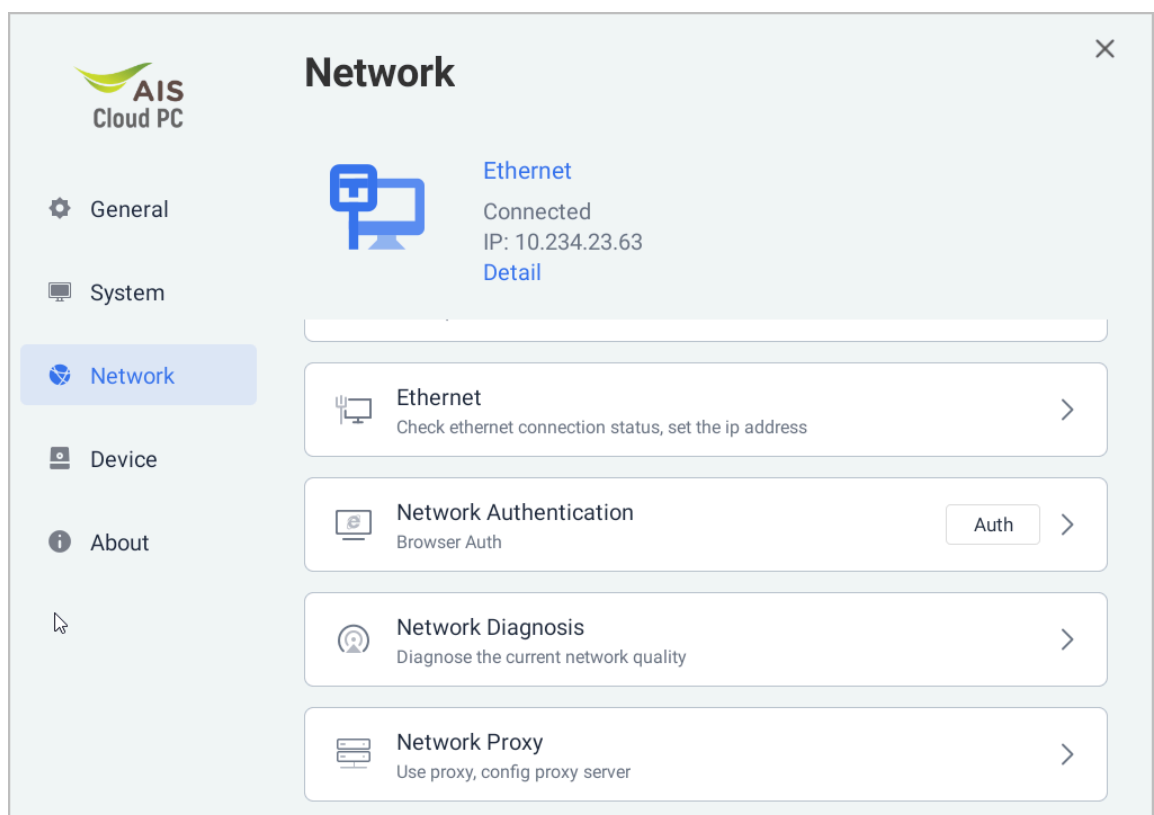

3. Click **Network Diagnosis**. The **Network/Network Diagnosis** window is displayed, see [Figure 7-16](#).

Figure 7-16 Network/Network Diagnosis Window

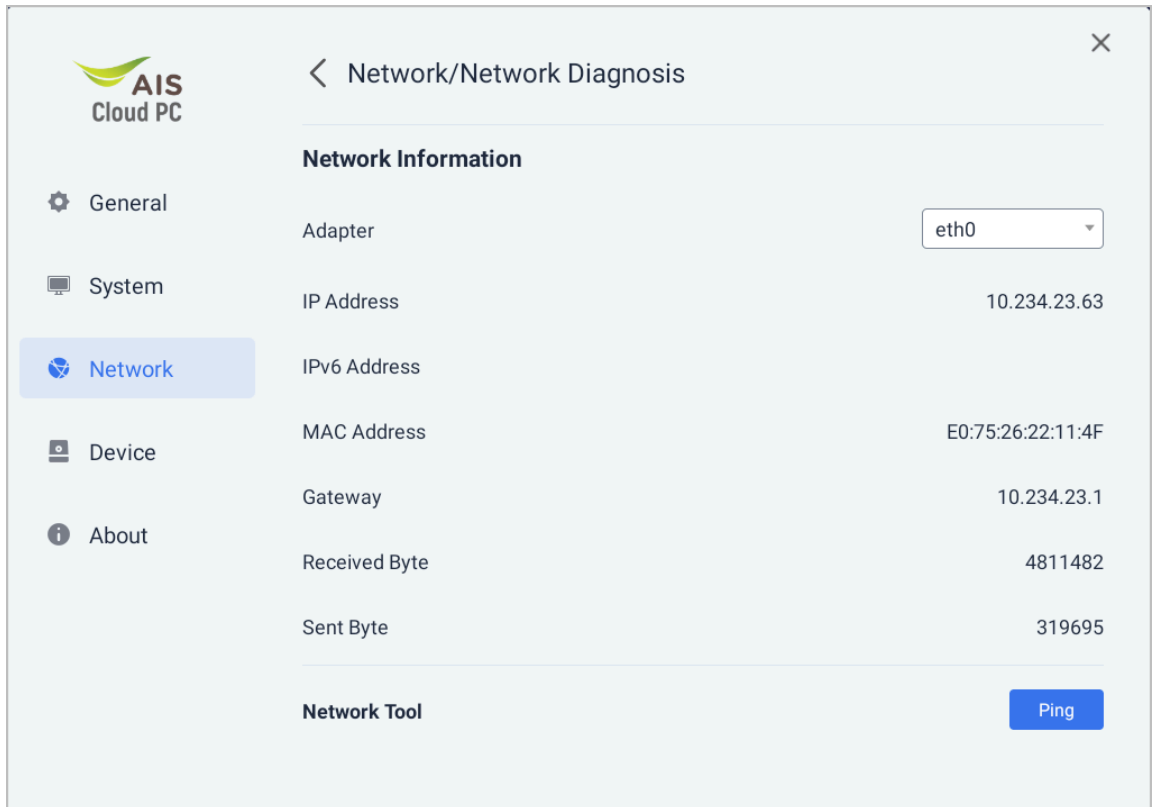

4. Perform the following operations as required.

To...	Do...
Check the network information	<p>Check the basic network information about the desired network adapter and the number of received and sent bytes.</p> <p>Note:</p> <ul style="list-style-type: none"> ● If the terminal is connected to a Wi-Fi network, the adapter is displayed as wlan0. ● If the terminal is connected to a wired network, the adapter is displayed as usb0. ● If the terminal is connected to both a wired network and a Wi-Fi network, both the wlan0 and usb0 adapters are available from the drop-down list.
Check network status	<ol style="list-style-type: none"> Click Ping. The Ping dialog box is displayed. Set Ping Address (peer IP address) and Number of Ping Packets. Click Ping. The current network status is displayed.

7.14 Connecting to a Bluetooth Device

Abstract

To connect the terminal to a Bluetooth device for the first time, you need to pair the terminal with the Bluetooth device.

Prerequisites

- The Bluetooth function is enabled on the Bluetooth device.
- The Bluetooth device is in pairing state if it is the first time that the terminal is to be paired with the Bluetooth device.



Note

For the detailed pairing operations of the Bluetooth device, you need to refer to the manual of the Bluetooth device.

Steps

1. In the floating toolbox of the console, click **More**. The window for settings is displayed.
2. Select **Device**. The **Device** window is displayed, see [Figure 7-17](#).

Figure 7-17 Device Window

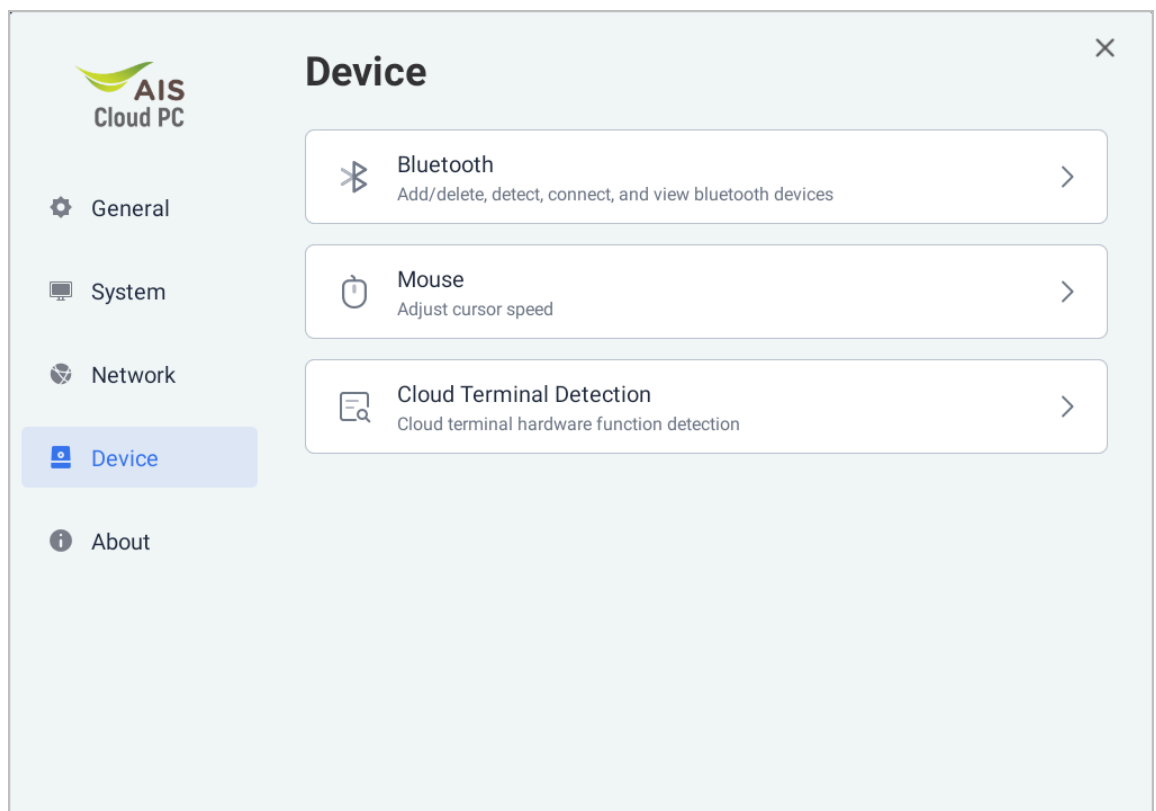

3. Click **Bluetooth**. The **Device/Bluetooth** window is displayed, see [Figure 7-18](#).

Figure 7-18 Device/Bluetooth Window

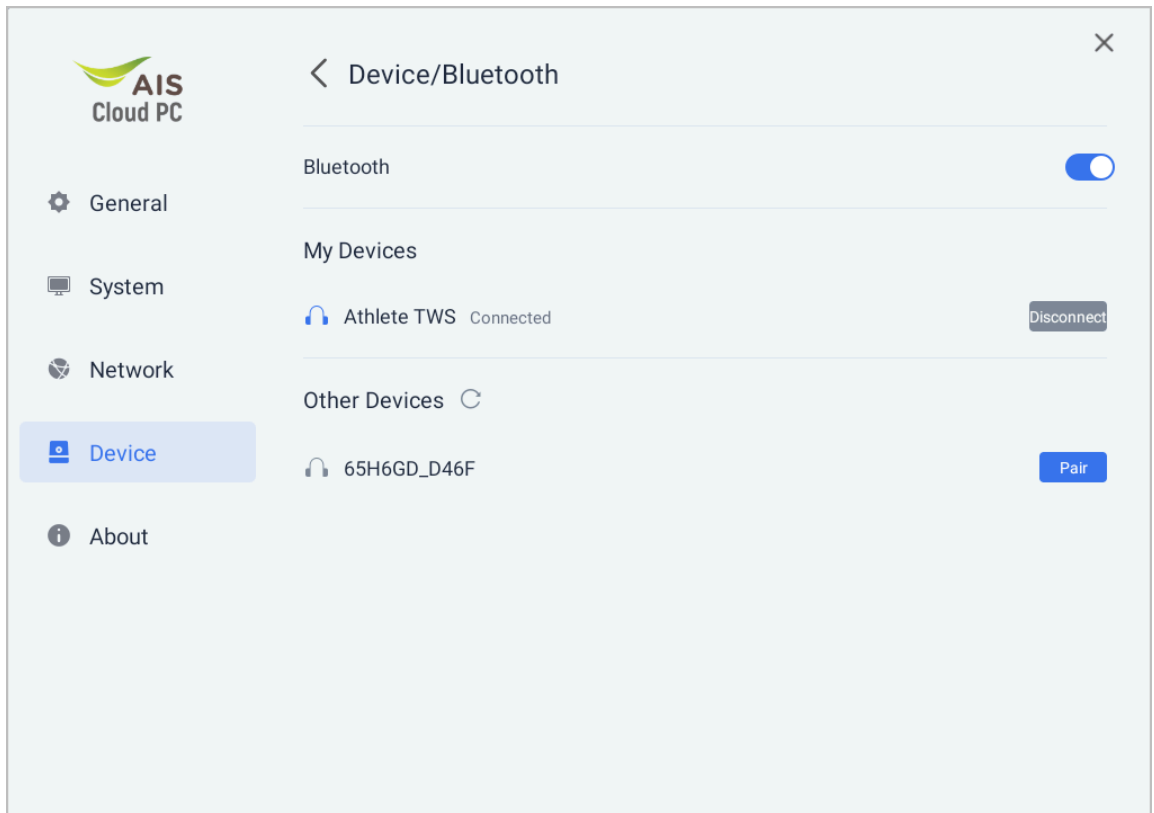

4. Turn **Bluetooth** on to enable the Bluetooth function and start discovering Bluetooth devices.

Note

The discovered Bluetooth devices are displayed in the **Other Devices/My Devices** list.

5. Perform the following operations as required.

If...	Then...
The Bluetooth device is connected to for the first time	In the Other Devices list, click Pair for the desired Bluetooth device. Note: After the terminal is paired with and connected to the Bluetooth device successfully, the Bluetooth device is saved in the My Devices list.
The Bluetooth device was once connected to successfully	In the My Devices list, click Connect for the desired Bluetooth device.

7.15 Adjusting the Mouse Pointer Speed

Abstract

You can adjust the mouse pointer speed based on your personal preference.

Steps

1. In the floating toolbox of the console, click **More**. The window for settings is displayed.
2. Select **Device**. The **Device** window is displayed.
3. Click **Mouse**. The **Device/Mouse** window is displayed, see [Figure 7-19](#).

Figure 7-19 Device/Mouse Window

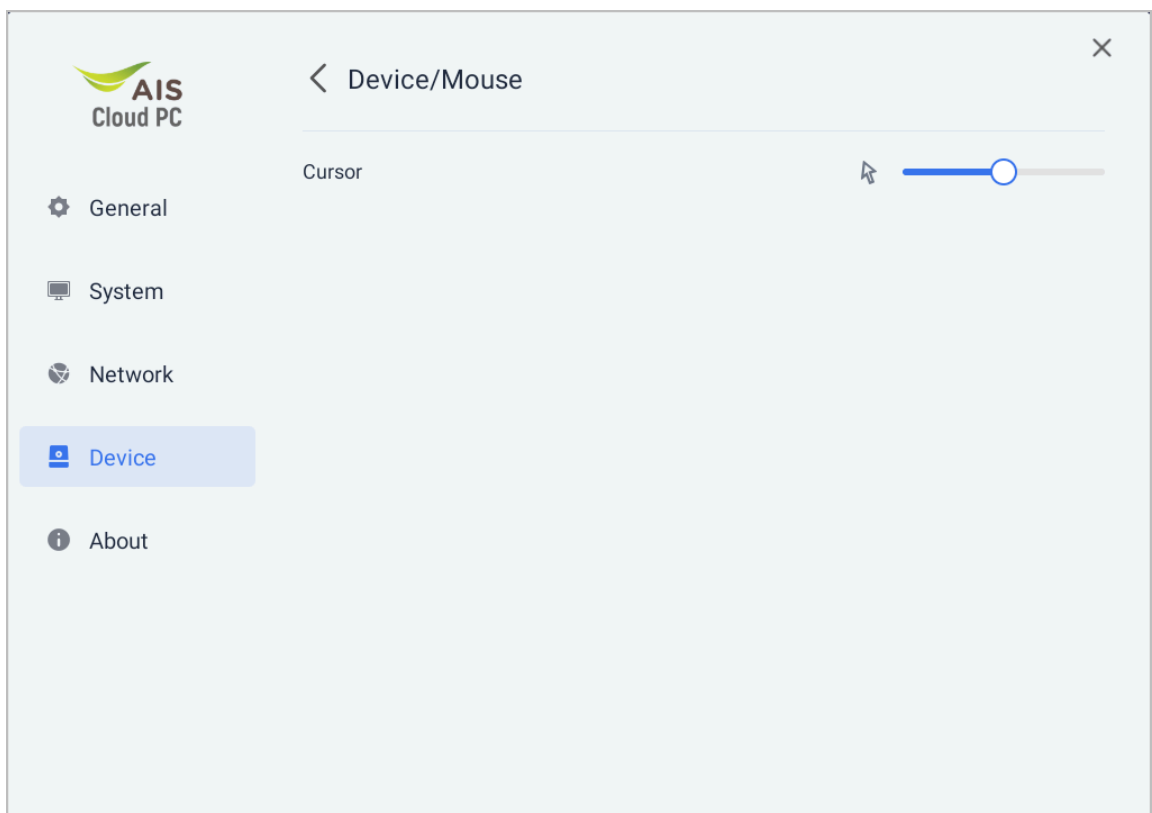

4. Drag the slider to adjust the mouse pointer speed as needed.

7.16 Testing the Hardware of a Cloud Terminal

Abstract

This procedure describes how to test whether the hardware of a cloud terminal is operating properly. You can save the test results to the local cloud terminal or a USB flash drive for fault location.

 **Note**

You need to manually check whether the USB and HDMI interfaces are normal. The system automatically checks whether the Bluetooth is normal.

Prerequisite

- You have disconnected the cloud terminal from the cloud desktop. For details, refer to [6.5 Logging Out of the Cloud Desktop](#).
- If you need to test a USB interface, the USB peripherals should be connected in advance.
- If the test results need to be saved to a USB flash drive, the USB flash drive must have been connected to the W106D.

Steps

1. In the floating toolbox of the console, click **More**. The window for settings is displayed.
2. Select **Device**. The **Device** window is displayed, see [Figure 7-21](#).

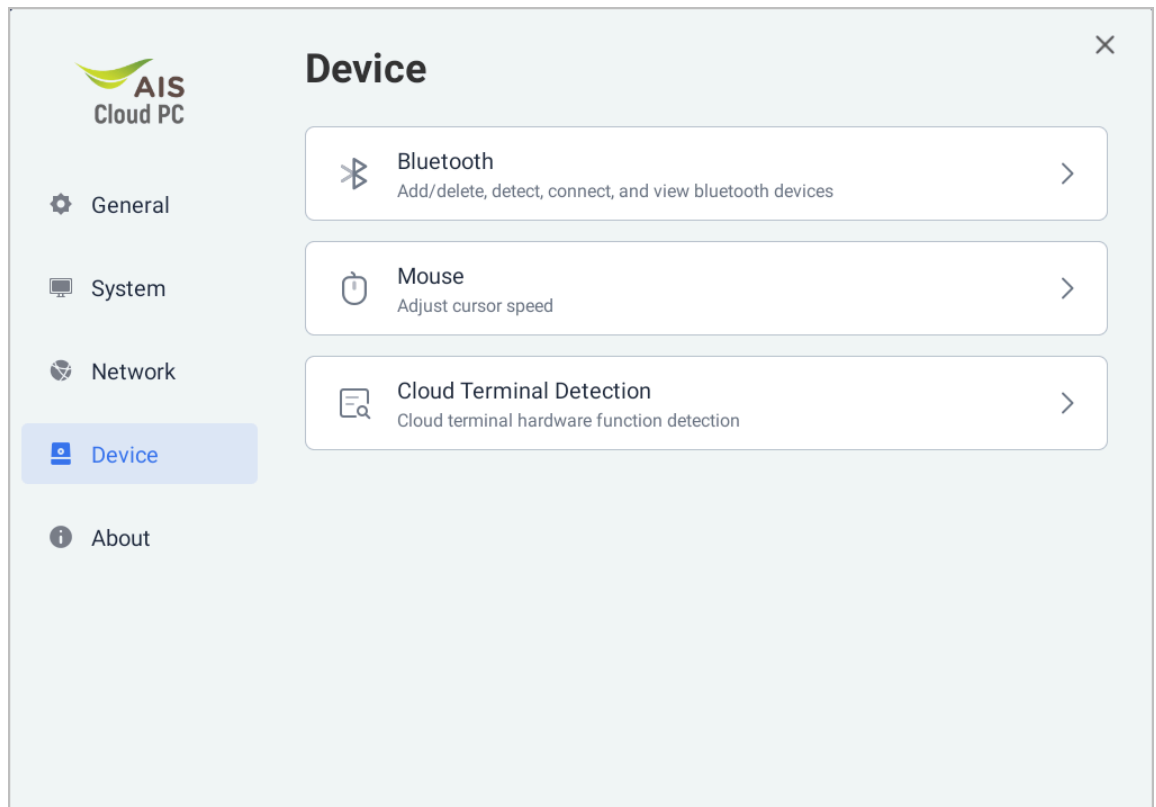
Figure 7-20 Device Window

3. Click **Cloud Terminal Detection**. A prompt window is displayed.
4. Click **Start**. The **Cloud Terminal Detection** screen is displayed, see [Figure 7-21](#).

Figure 7-21 Cloud Terminal Detection Screen

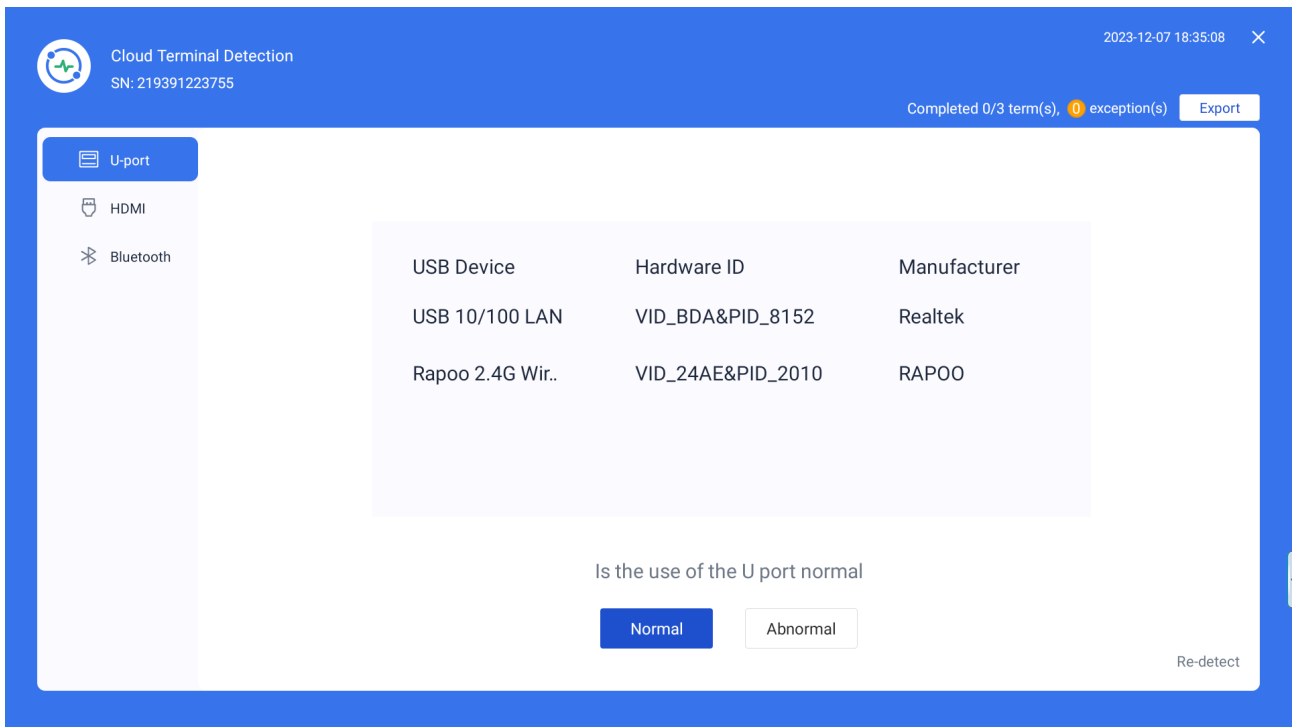

5. Perform the following operations to test one or more components as required.

To...	Do...
Test a USB interface	<ol style="list-style-type: none"> Select U-port on the left. Click Start. The USB peripherals connected to the cloud terminal are displayed in the test results. Based on the test results, check whether the USB interface is normal and click Normal or Abnormal.
Test an HDMI interface	<ol style="list-style-type: none"> Select HDMI on the left. Click Start. A video is automatically played. Based on the video, check whether the HDMI interface is normal and click Normal or Abnormal.
Test the Bluetooth	<ol style="list-style-type: none"> Enable the Bluetooth function (for details, refer to " 7.14 Connecting to a Bluetooth Device "). Select Bluetooth on the left. The system automatically checks the Bluetooth. The system automatically checks whether the Bluetooth function operates properly. Manual operation is not required.

6. Click **Export**. A prompt for saving the test results is displayed, see [Figure 7-22](#).

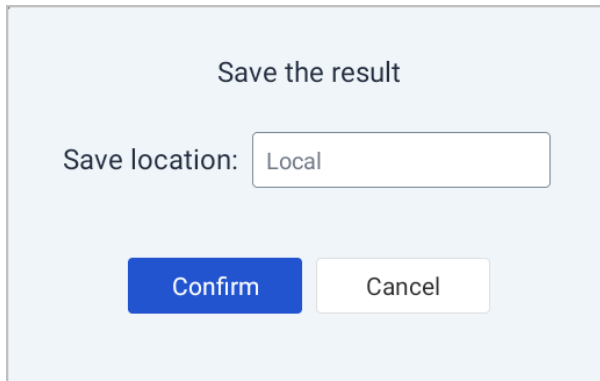
Figure 7-22 Saving the Test Results

7. Select a storage location from the **Save location** list and then click **Confirm**.

7.17 Viewing Version Information

Abstract

This procedure describes how to view the current version information of the terminal.

Steps

1. In the floating toolbox of the console, click **More**. The window for settings is displayed.
2. Select **About**. The **About** window is displayed, see [Figure 7-23](#).

Figure 7-23 About Window

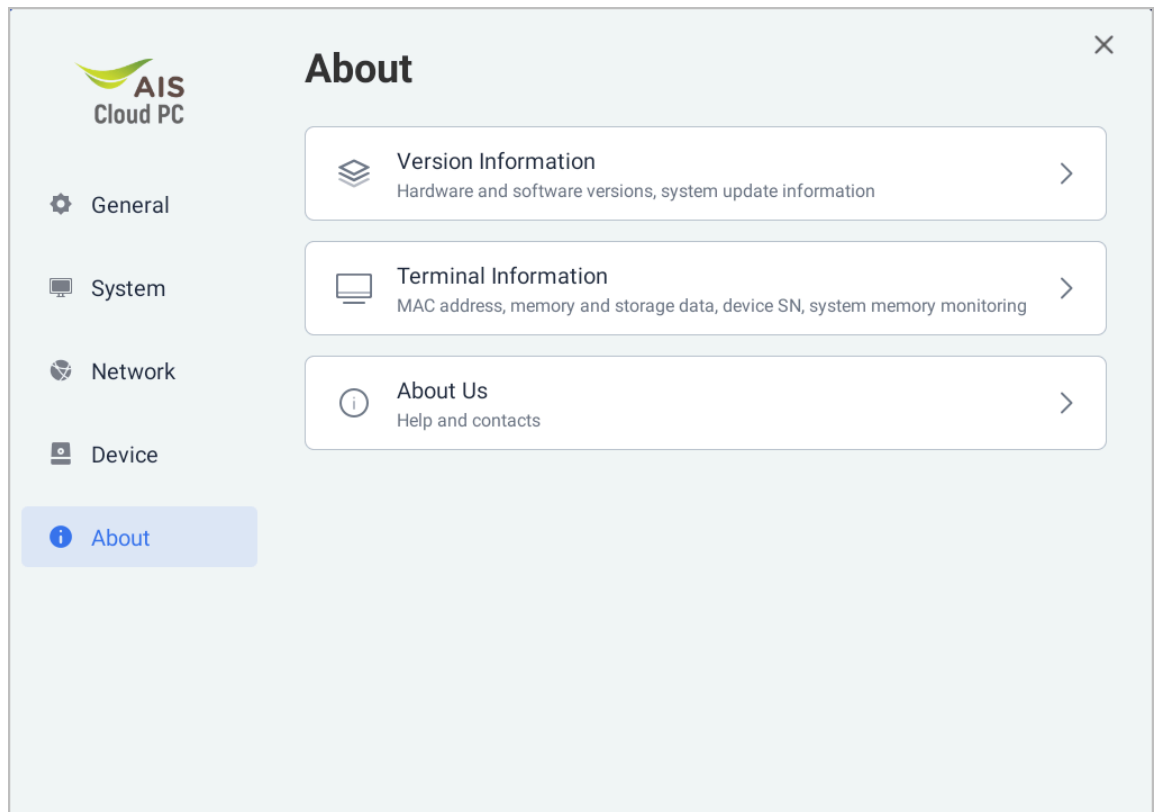

3. Click **Version Information**. The **About/Version Information** window is displayed, see [Figure 7-24](#).

Figure 7-24 About/Version Information Window

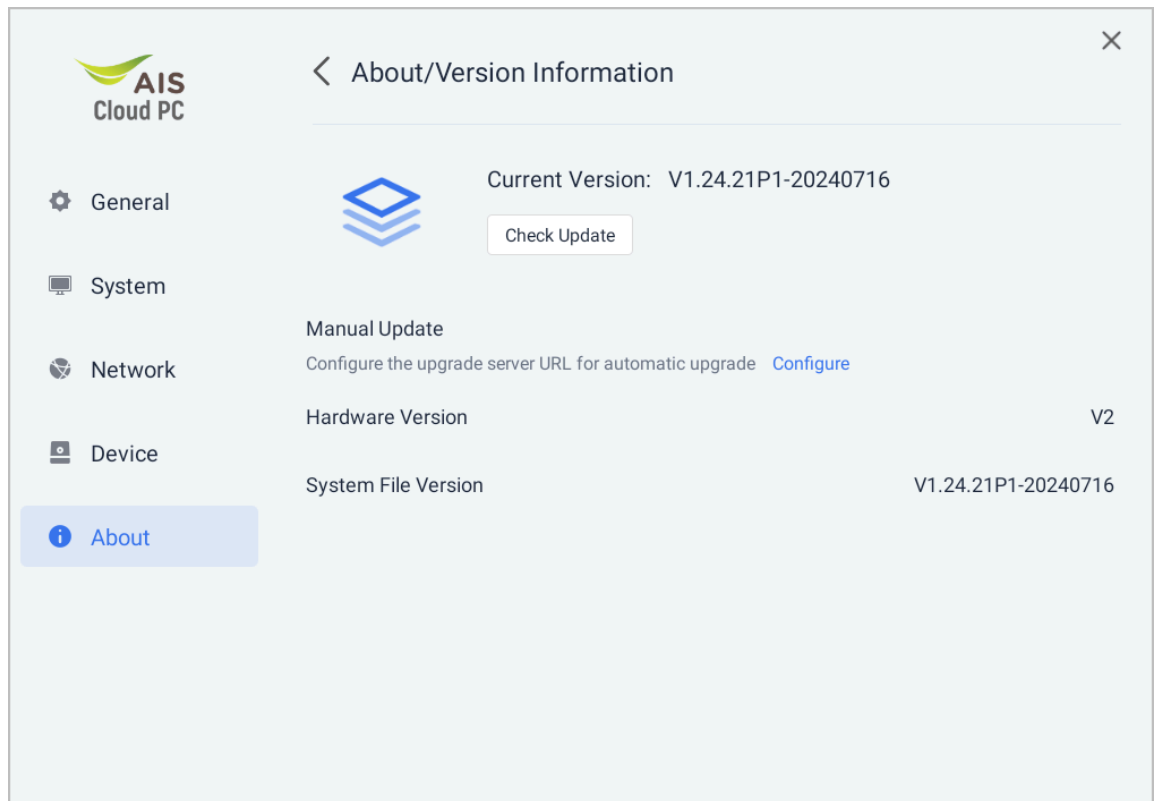

7.18 Updating System Software

Abstract

The system software update procedure is described as follows:

- Restart or power on the terminal. After the terminal is started, the terminal detects the address of the update server. If the latest software package is available on the update server, the terminal automatically downloads the software package in silent mode. After the download, you can choose to update the system immediately or later.
- No restart or power-on operation is performed. Instead, you manually perform an update check. If a new software package is available on the server, the terminal automatically downloads the new software package. After the download, you can choose to update the system immediately or later.

Note

After the software package is downloaded completely, an update prompt dialog box is displayed, allowing you to choose whether to update the system software immediately or not. If you choose not to perform the operation immediately, you can do it later in the **About/Version Information** window.

Steps

1. In the floating toolbox of the console, click **More**. The window for settings is displayed.
2. Select **About**. The **About** window is displayed.
3. Click **Version Information**. The **About/Version Information** window is displayed, see [Figure 7-25](#).

Figure 7-25 About/Version Information Window

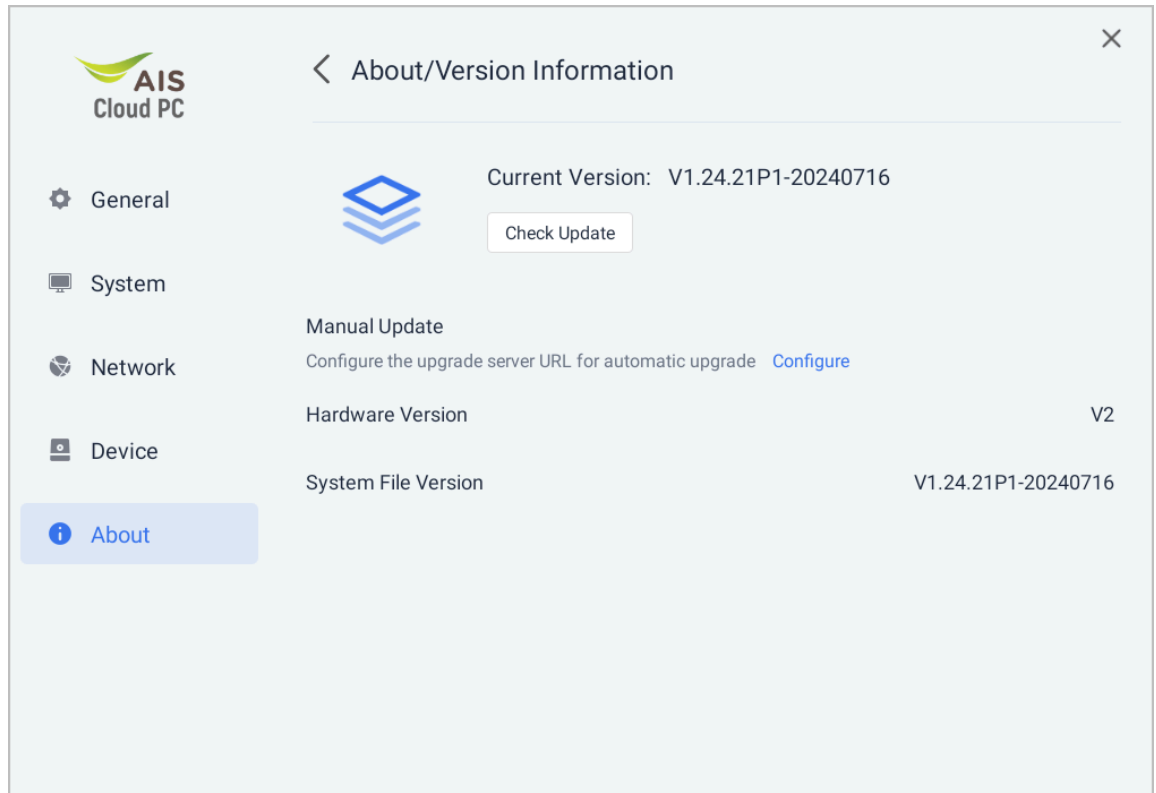

4. (Optional) Click **Configure**. Set the IP address of the auto-update server as planned.

Note

If you perform the restart or power-on operation, the terminal automatically downloads the latest software package. After the download, an update prompt dialog box is displayed. You can choose to update the system software immediately or later.

5. (Optional) Click **Check Update**. The terminal starts checking the software packages on the server. If a new software package is available, the terminal automatically downloads it. After the download (see [Figure 7-26](#)), click **Update Now** to update the system software immediately.

Figure 7-26 Update Now Button

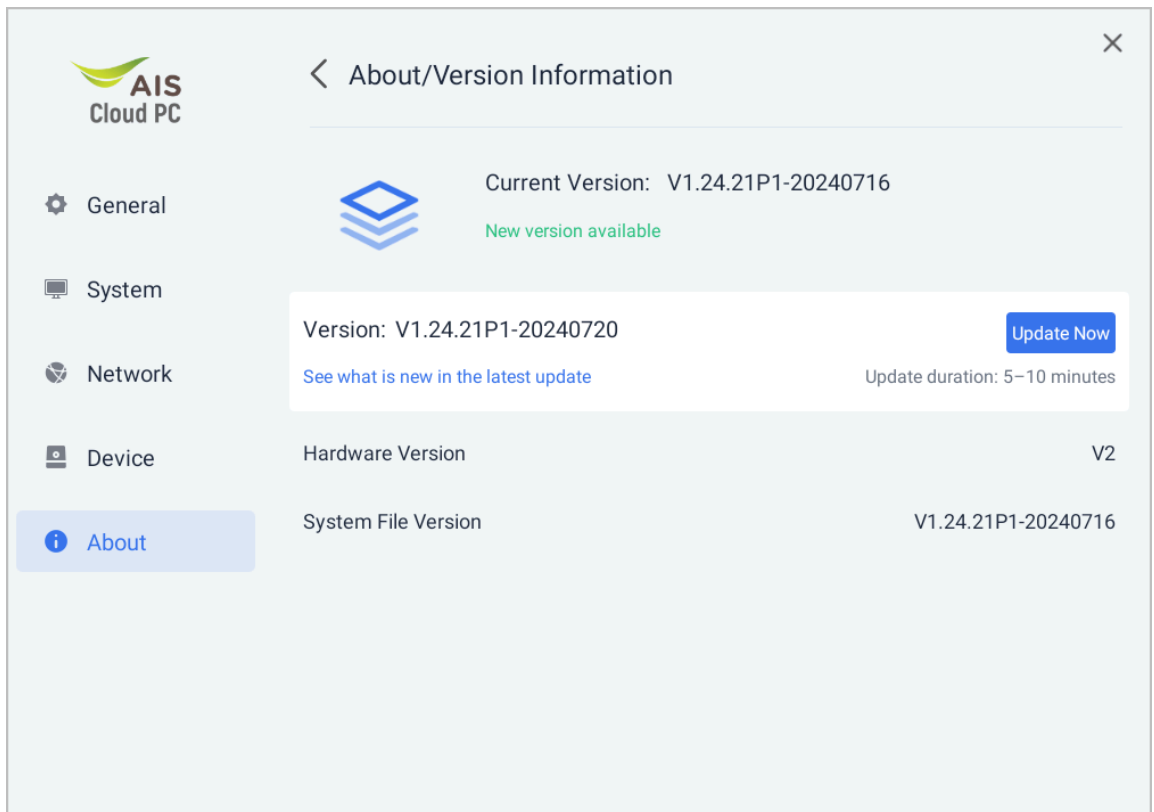

7.19 Checking Terminal Information

Abstract

You can check the following information about the terminal:

- Terminal hardware information, including the MAC address, resolution, CPU, memory, storage, and device SN.
- Current usage of terminal resources, including the CPU usage, memory usage, and storage usage.

Steps

1. In the floating toolbox of the console, click **More**. The window for settings is displayed.
2. Select **About**. The **About** window is displayed.
3. Click the **Terminal Information** tab. The **Terminal Information** tab is displayed, see [Figure 7-27](#).

Figure 7-27 Terminal Information Tab

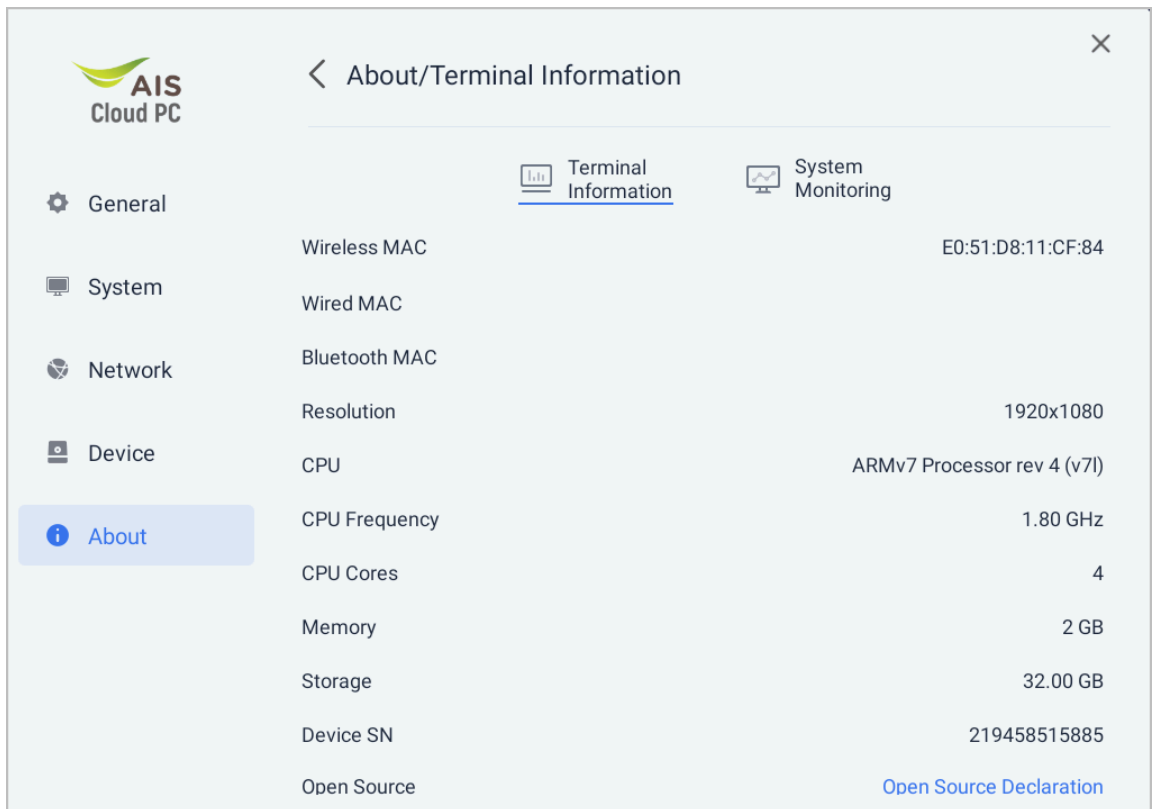

4. Click the **System Monitoring** tab. The resource usage is displayed, see [Figure 7-28](#).

Figure 7-28 System Monitoring Tab

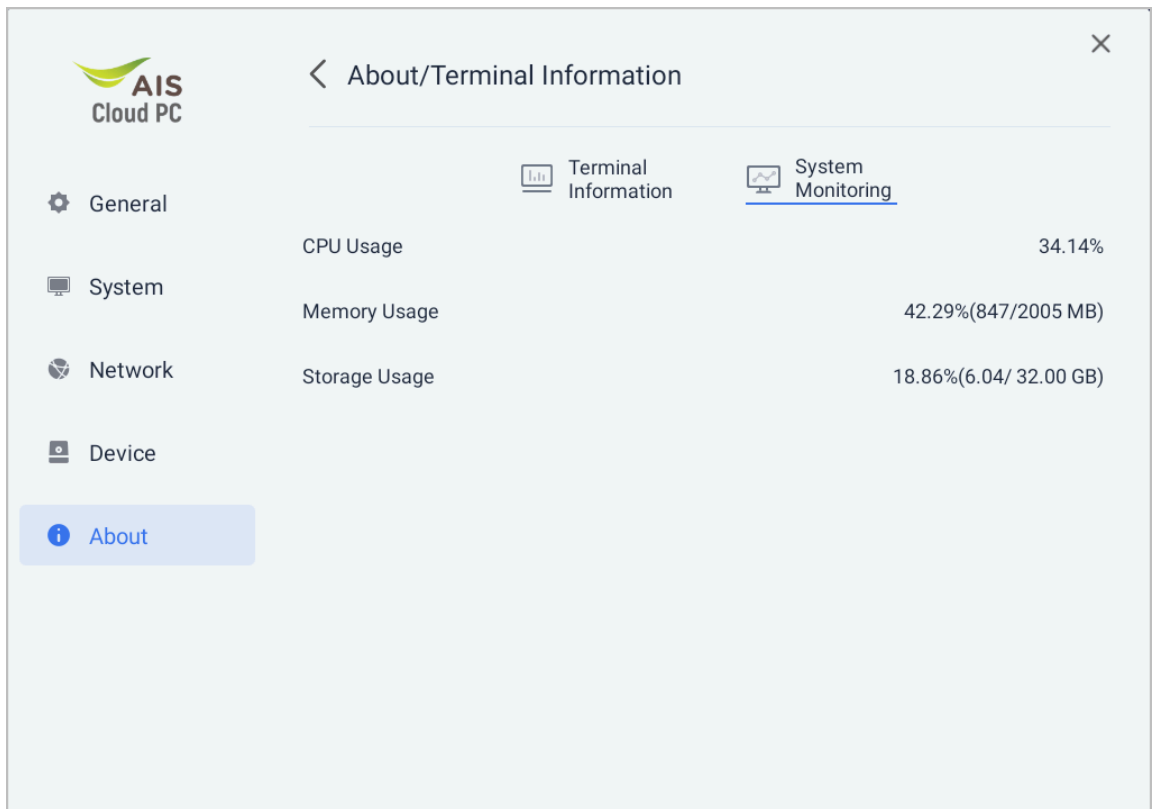

7.20 Contacting ZTE Technical Support

Abstract

This procedure describes how to check the help information about the terminal to contact ZTE technical support.

Steps

1. In the floating toolbox of the console, click **More**. The window for settings is displayed.
2. Select **About**. The **About** window is displayed.
3. Click **About Us**. The **About/About Us** window is displayed, see [Figure 7-29](#).

Figure 7-29 About/About Us Window

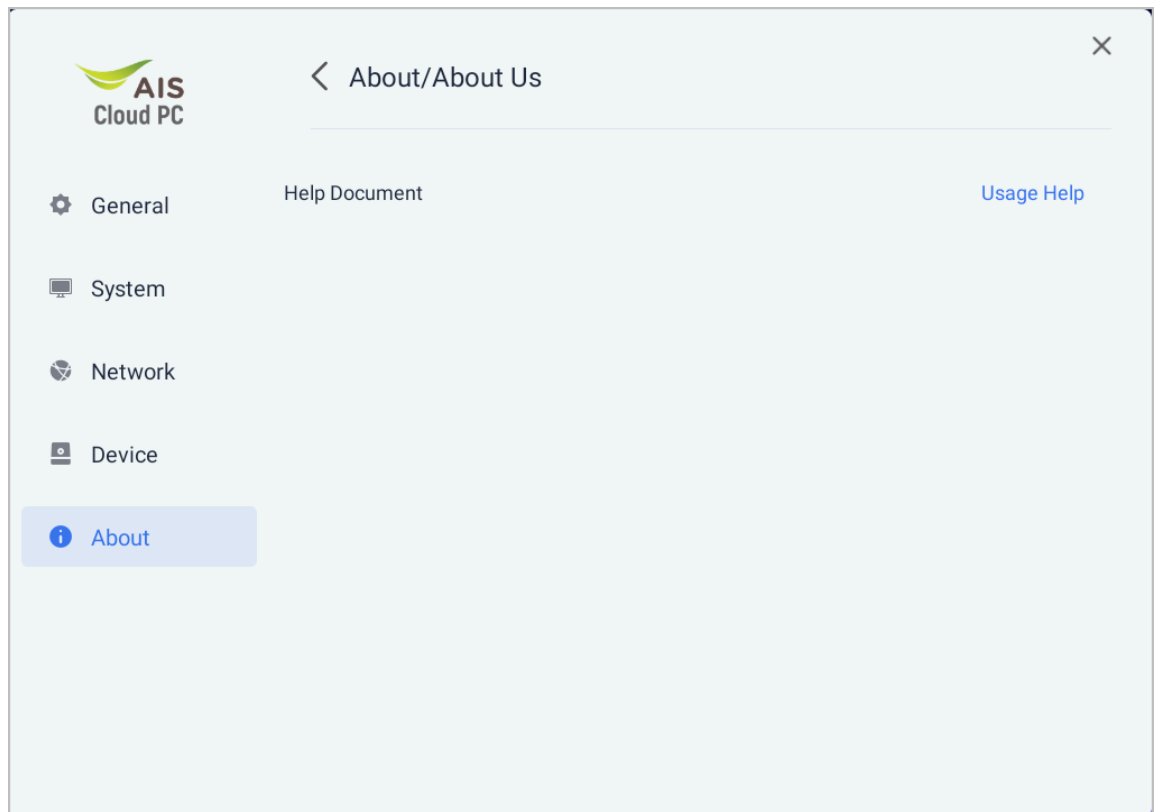

4. Click **Usage Help**. The **Help** dialog box is displayed.

7.21 Viewing the Last Login Information

Abstract

On the cloud desktop list screen, you can check the time and IP address of the account's last login to ensure account security.

Steps

1. After logging in to the cloud desktop, move the mouse pointer to the center of the top of the cloud desktop. The cloud desktop toolbar is displayed automatically.
2. Click **Disconnect** to disconnect the terminal from the cloud desktop. The cloud desktop list screen is displayed.
3. Click **Desktop settings**. The **Desktop settings** window is displayed.
4. Select **Account**. The **Account** window is displayed, see [Figure 7-30](#).

Figure 7-30 Account Window

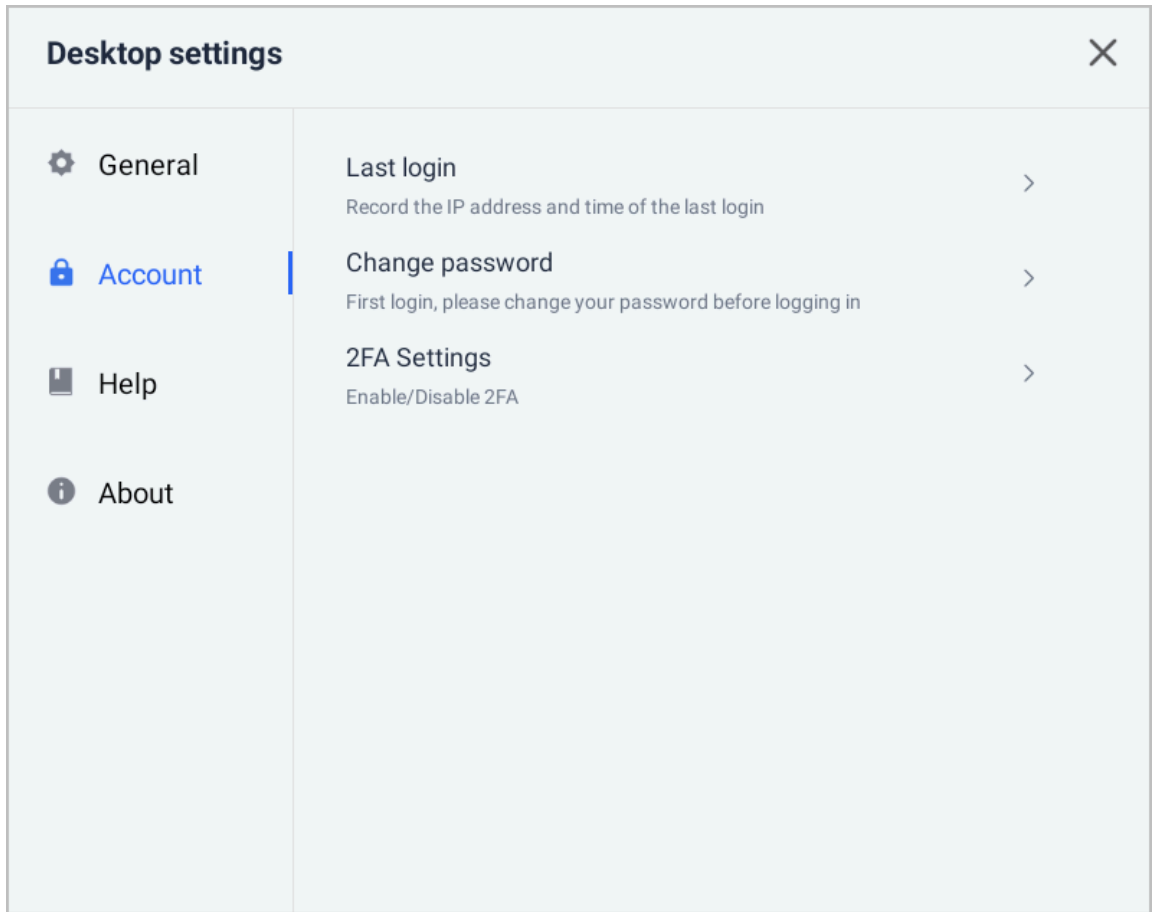

5. Click **Last login**. The **Last Login** window is displayed, see [Figure 7-31](#).

Figure 7-31 Last Login Window

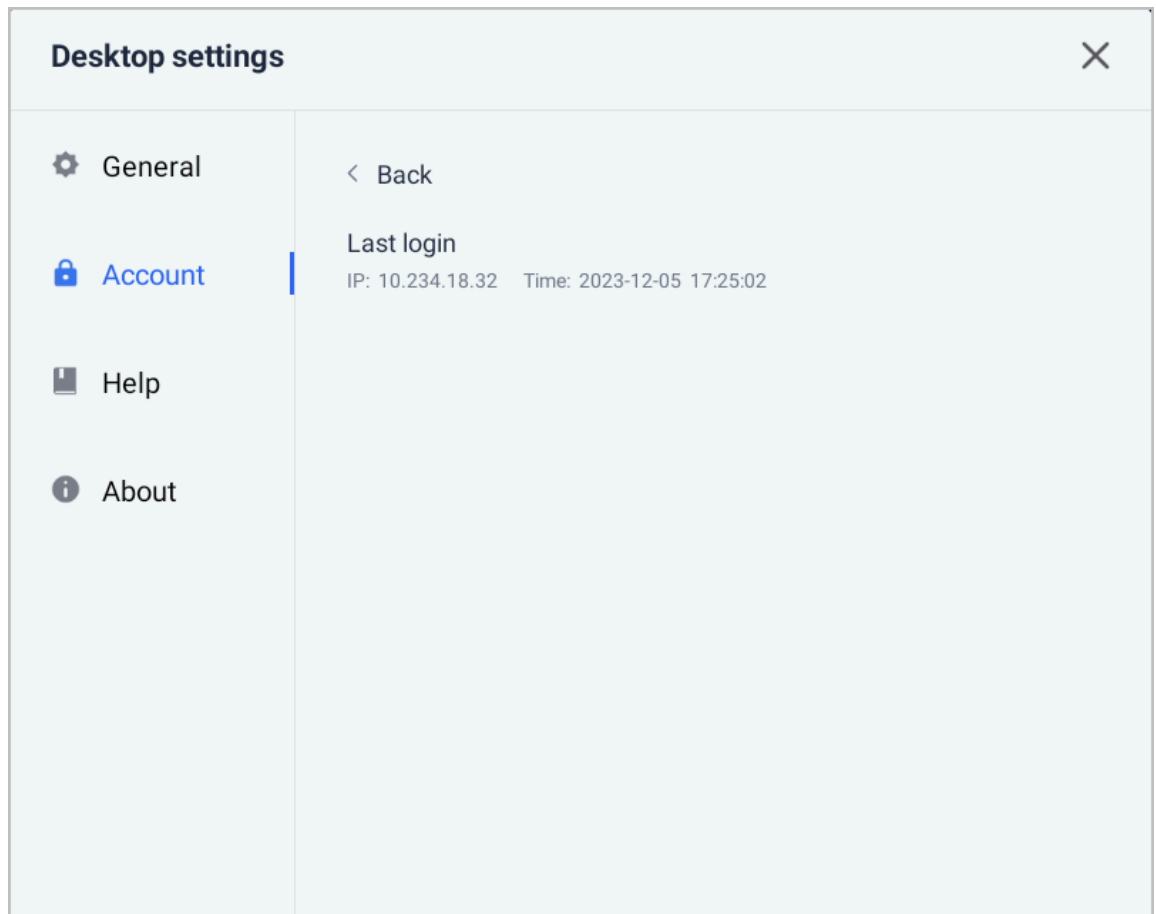

7.22 Set Authentication Mode

Abstract

The device W106D supports multiple authentication methods:

- Username/Password
- SMS authentication
- Google/Microsoft authentication

Prerequisites

The Google/Microsoft Authenticator app has been installed.

Steps

1. After logging in to the cloud desktop, move the mouse pointer to the center of the top of the cloud desktop. The cloud desktop toolbar is displayed automatically.
2. Click **Disconnect** to disconnect the terminal from the cloud desktop. The cloud desktop list screen is displayed.

3. Click **Desktop settings**. The **Desktop settings** window is displayed.
4. Select **Account**. The **Account** window is displayed.
5. Click **2FA Settings**. The page for set suthentication mode is displayed, see [Figure 7-32](#).

Figure 7-32 Set Authentication Mode-1

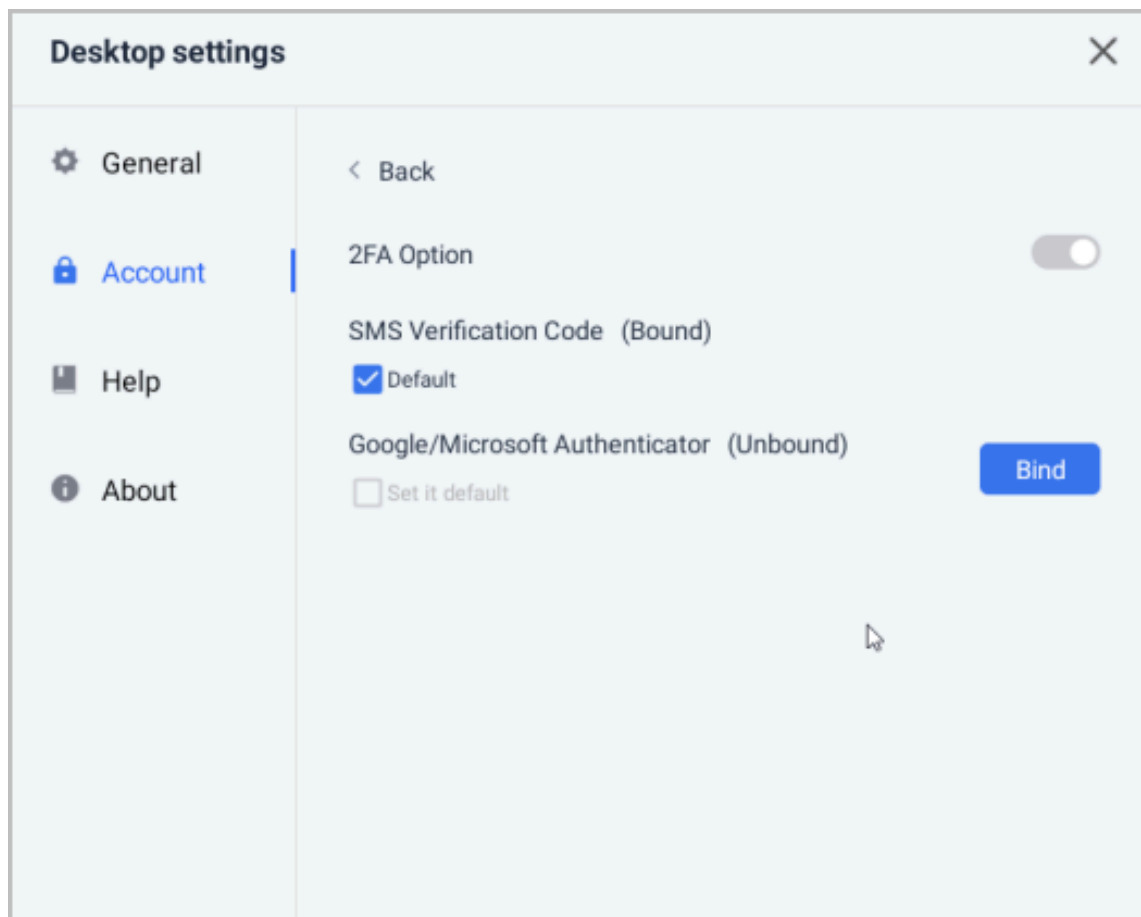

6. Enable **2FA Option**.
7. Click **Bind** next to Google/Microsoft Authentication. The page for QR code is displayed, see [Figure 7-33](#).

Figure 7-33 QR Code

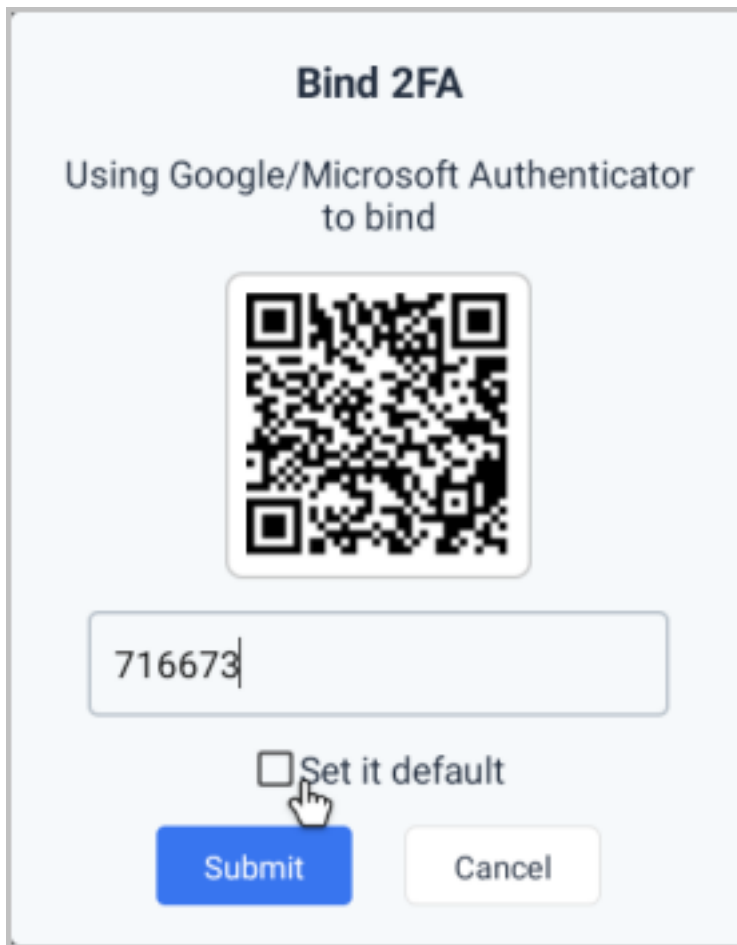

Bind 2FA

Using Google/Microsoft Authenticator
to bind



716673

Set it default

Submit Cancel

8. Open the Google/Microsoft Authenticator app, scan the QR code, and enter the scan result. The page for set authentication mode is displayed, see [Figure 7-34](#).

Figure 7-34 Set Authentication Mode-2

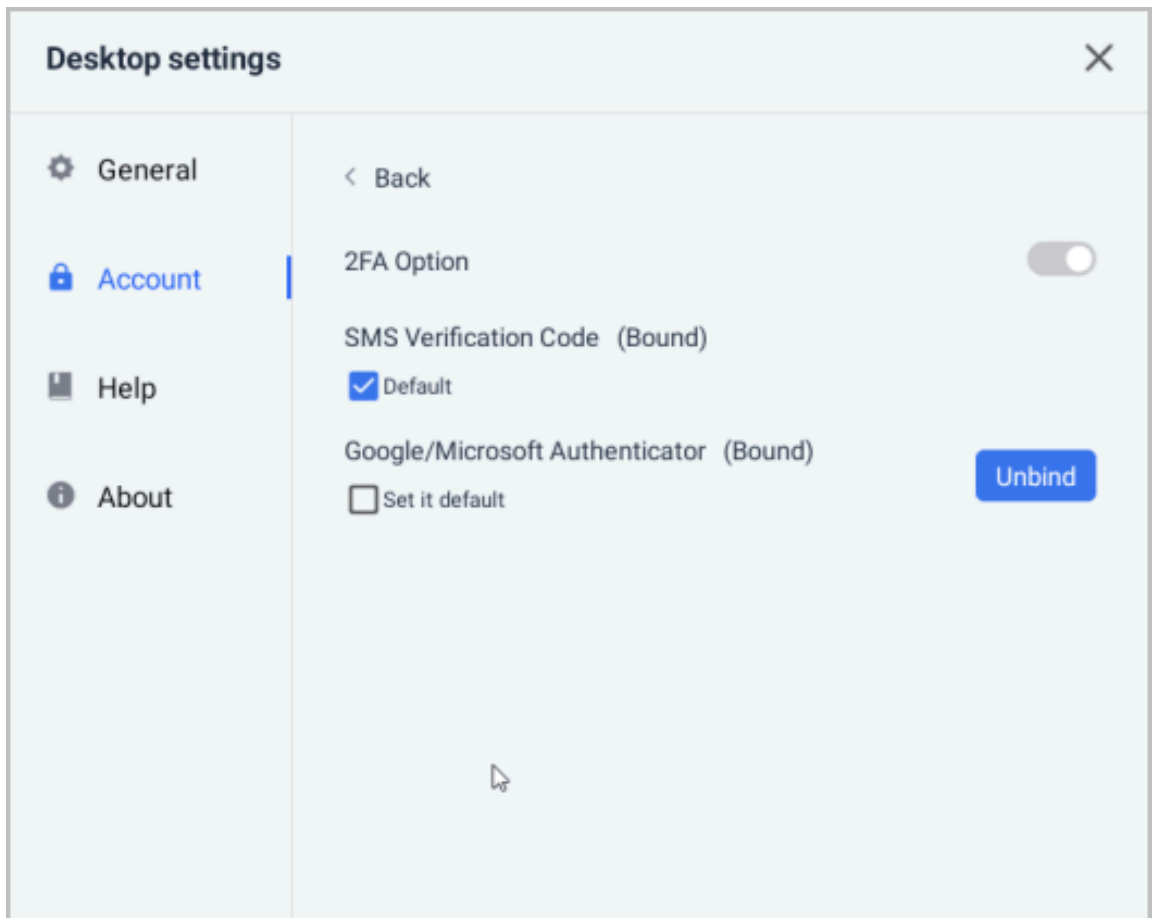

9. Set the default authentication method as needed (for example, Google/Microsoft Authenticator).
10. (Optional) Use the default authentication method for login verification.

7.23 Changing the Password

Abstract

You can periodically change your password to ensure account security.

Note

You should enter the new password twice. The password should meet the following requirements:

- It consists of 8 to 20 characters.
- It must contain at least three of the following types: uppercase letters, lowercase letters, digits, and special characters.

Steps

1. After logging in to the cloud desktop, move the mouse pointer to the center of the top of the cloud desktop. The cloud desktop toolbar is displayed automatically.

2. Click **Disconnect** to disconnect the terminal from the cloud desktop. The cloud desktop list screen is displayed.
3. Click **Desktop settings**. The **Desktop settings** window is displayed.
4. Select **Account**. The **Account** window is displayed.
5. Click **Change Password**. The page for changing the password is displayed, see [Figure 7-35](#).

Figure 7-35 Changing the Password

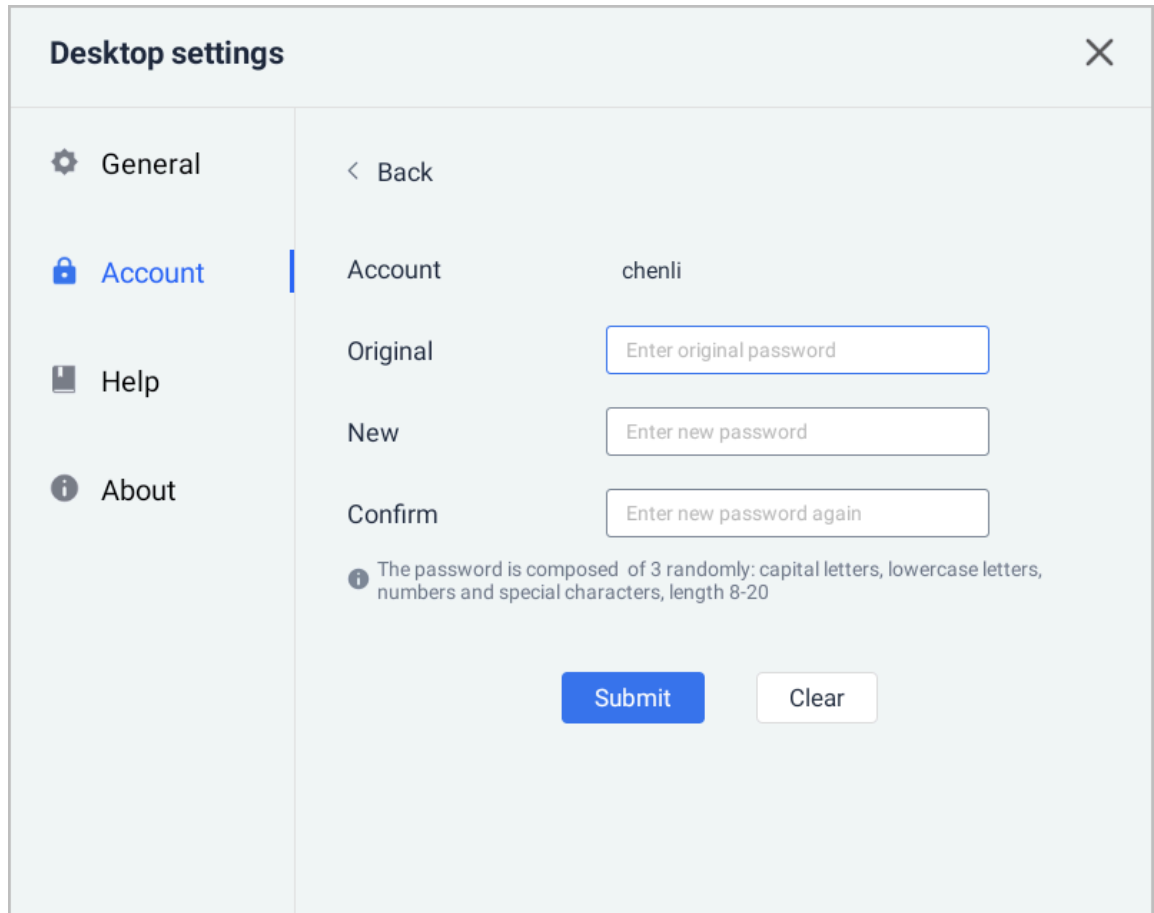

The screenshot shows a 'Desktop settings' window with a sidebar on the left containing 'General', 'Account', 'Help', and 'About'. The 'Account' section is active. The main content area shows a 'Back' link, the current 'Account' name 'chenli', and three password input fields labeled 'Original', 'New', and 'Confirm'. Below the fields is a password requirement note: 'The password is composed of 3 randomly: capital letters, lowercase letters, numbers and special characters, length 8-20'. At the bottom are 'Submit' and 'Clear' buttons.

Account	chenli
Original	<input type="text" value="Enter original password"/>
New	<input type="text" value="Enter new password"/>
Confirm	<input type="text" value="Enter new password again"/>

The password is composed of 3 randomly: capital letters, lowercase letters, numbers and special characters, length 8-20

6. Enter the original password. Then, enter the new password twice and click **Submit**.

Chapter 8

Cloud Desktop Operation Guide

Table of Contents

Cloud Desktop Toolbar.....	62
Setting General Desktop Parameters.....	63
Managing Peripherals.....	64
Checking the Help Information and Providing the Feedback Information.....	66
Viewing the Privacy Policy.....	67
Checking the Environment Information.....	68
Restarting a Cloud Desktop.....	68

8.1 Cloud Desktop Toolbar

After logging in to the cloud desktop through the W106D, you can move the mouse pointer to the top center of the cloud desktop. The cloud desktop toolbar is displayed automatically.

Figure 8-1 Cloud Desktop Toolbar

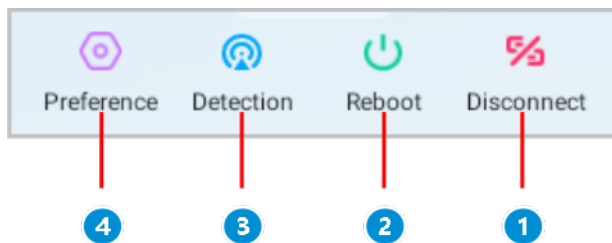

No.	Button	Function Description
1	Disconnect	Disconnects the terminal from the cloud desktop. The cloud desktop list screen is displayed.
2	Reboot	Restarts the cloud desktop forcibly.
3	Detection	Detects the network connection between the terminal and the cloud server, and checks the network quality statistics.
4	Preference	Sets the desktop attributes of the cloud desktop, including image quality settings, login settings, camera settings, and help and feedback settings.

8.2 Setting General Desktop Parameters

Abstract

This procedure describes how to set the desktop parameters, including the desktop image quality, whether to automatically enter the desktop, and whether to automatically hide the desktop toolbar.

Steps

1. After logging in to the cloud desktop, move the mouse pointer to the top center of the cloud desktop. The cloud desktop toolbar is displayed automatically.
2. Click **Preference**. The **Desktop Settings** window is displayed, see [Figure 8-2](#).

Figure 8-2 Desktop Settings Window

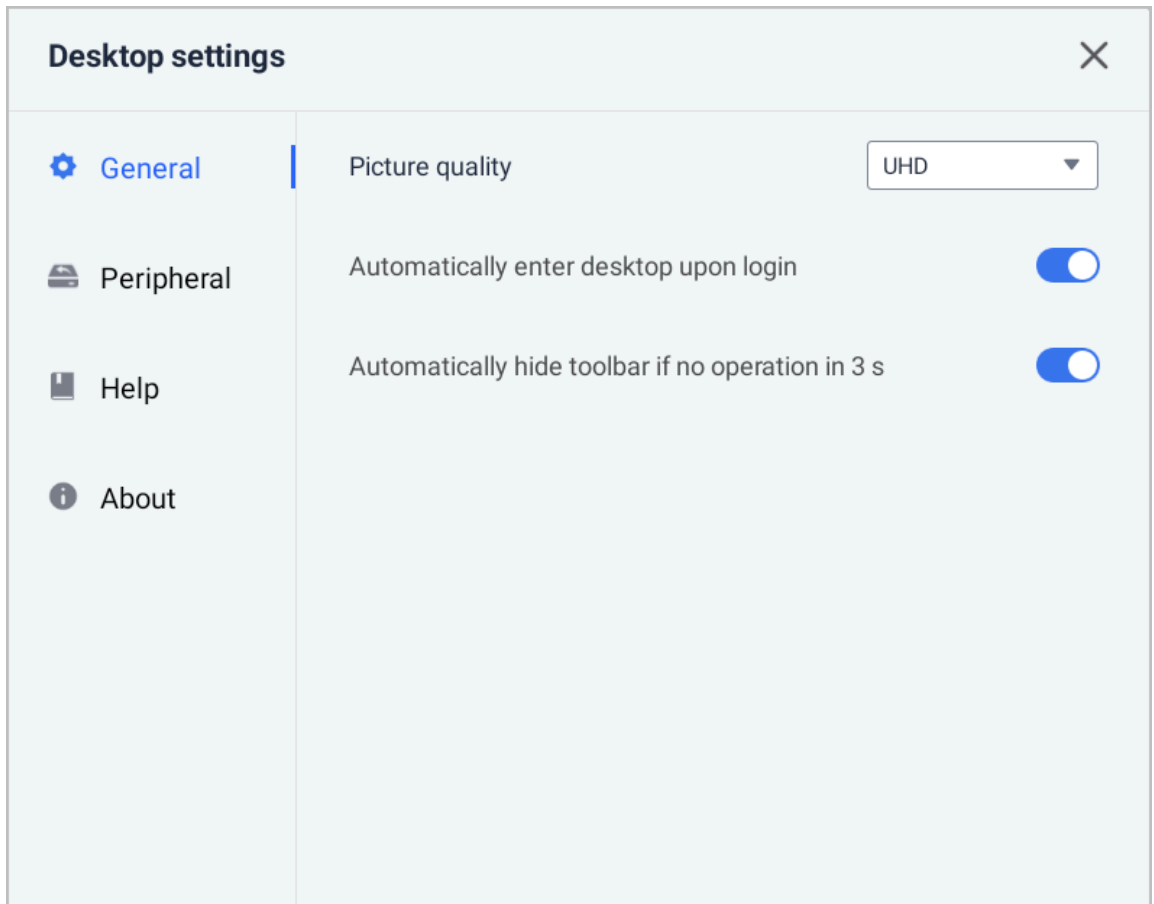

3. Set the general desktop parameters as required.

To...	Do...
Adjust the desktop image quality in accordance with the current network	Select an image quality option from the Picture quality list. Options: UHD, DN, and SD.

To...	Do...
Set whether to enter the desktop directly	<ul style="list-style-type: none"> ● Turn Automatically enter desktop upon login on. After login, you can directly enter the cloud desktop. By default, Automatically enter desktop upon login is on. ● Turn Automatically enter desktop upon login off. After login, the cloud desktop list is displayed.
Set whether to automatically hide the desktop toolbar	<ul style="list-style-type: none"> ● Turn Automatically hide toolbar if no operation in 3 s on. If no operation is performed within 3 seconds, the toolbar is automatically hidden. By default, Automatically hide toolbar if no operation in 3 s is on. ● Turn Automatically hide toolbar if no operation in 3 s off. The toolbar is not hidden.

8.3 Managing Peripherals

Abstract

This procedure describes how to manage peripherals, including the USB device storage mode and camera application scenario.

Steps

1. After logging in to the cloud desktop, move the mouse pointer to the top center of cloud desktop. The cloud desktop toolbar is displayed automatically.
2. Click **Preference**. The **Desktop settings** window is displayed.
3. Select **Peripheral**. The **Peripheral** window is displayed, see [Figure 8-3](#).

Figure 8-3 Peripheral Window

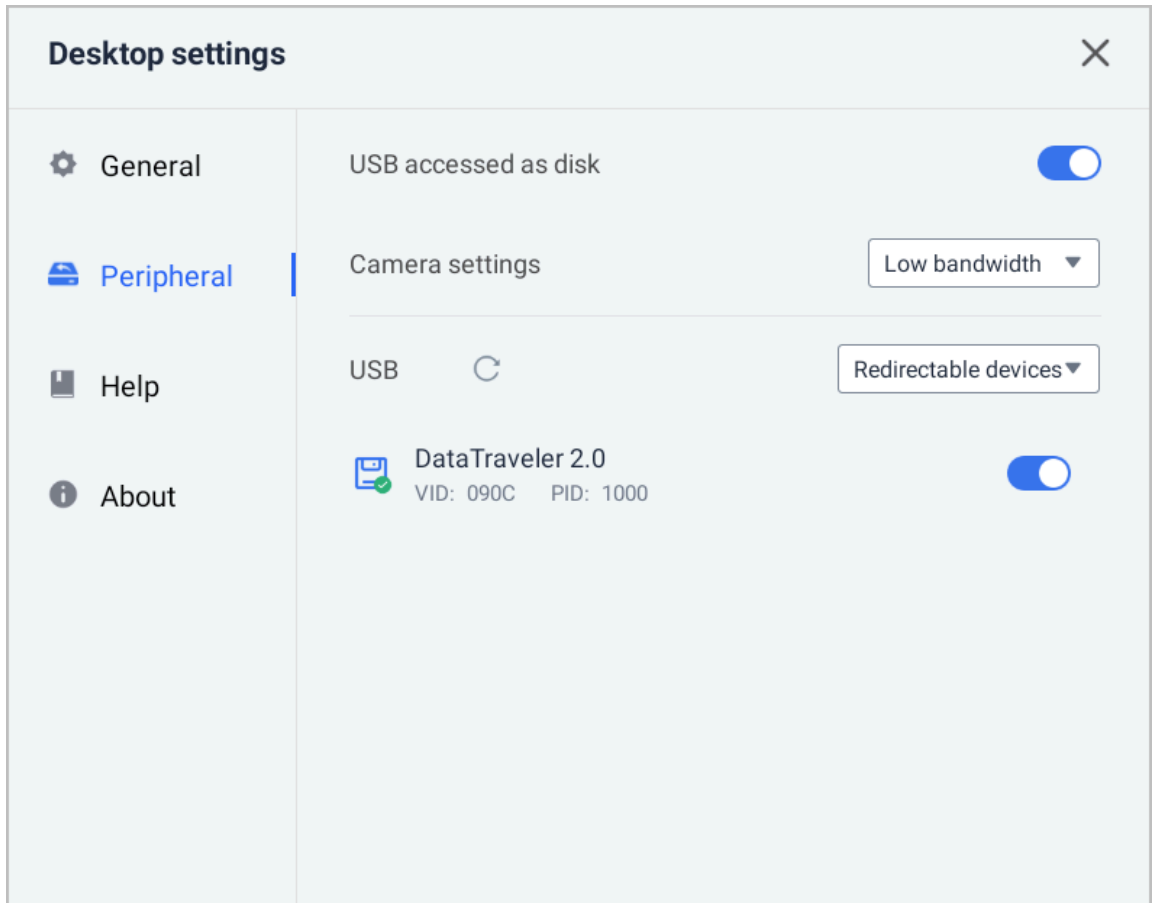

4. Manage the peripherals as required.

To...	Do...
Set the USB storage access mode	<ul style="list-style-type: none"> ● Turn USB accessed as disk on. The USB storage device is accessed in disk mode. ● Turn USB accessed as disk off. The USB storage device is accessed in USB mode (default).
Set the camera application scenario	<p>When using the camera, you need to adjust the camera settings based on the network conditions:</p> <ul style="list-style-type: none"> ● High image quality: displays images in real time, imposing high requirements upon network bandwidth. ● Low bandwidth: used when the network quality is poor. ● Standard mode: used when no requirements are imposed on the images.
Check the USB device redirection	No operation is required. The redirection information of the connected USB device is displayed. For example, Serverpolicy restriction indicates that the device cannot be redirected.

8.4 Checking the Help Information and Providing the Feedback Information

Abstract

When using the cloud desktop, you can check the help information if you need help. If a fault occurs, you can upload logs for the administrator to locate the fault.

Steps

1. After logging in to the cloud desktop, move the mouse pointer to the top center of the cloud desktop. The cloud desktop toolbar is displayed automatically.
2. Click **Preference**. The **Desktop settings** window is displayed.
3. Click **Help**. The **Help** window is displayed, see [Figure 8-4](#).

Figure 8-4 Help Window

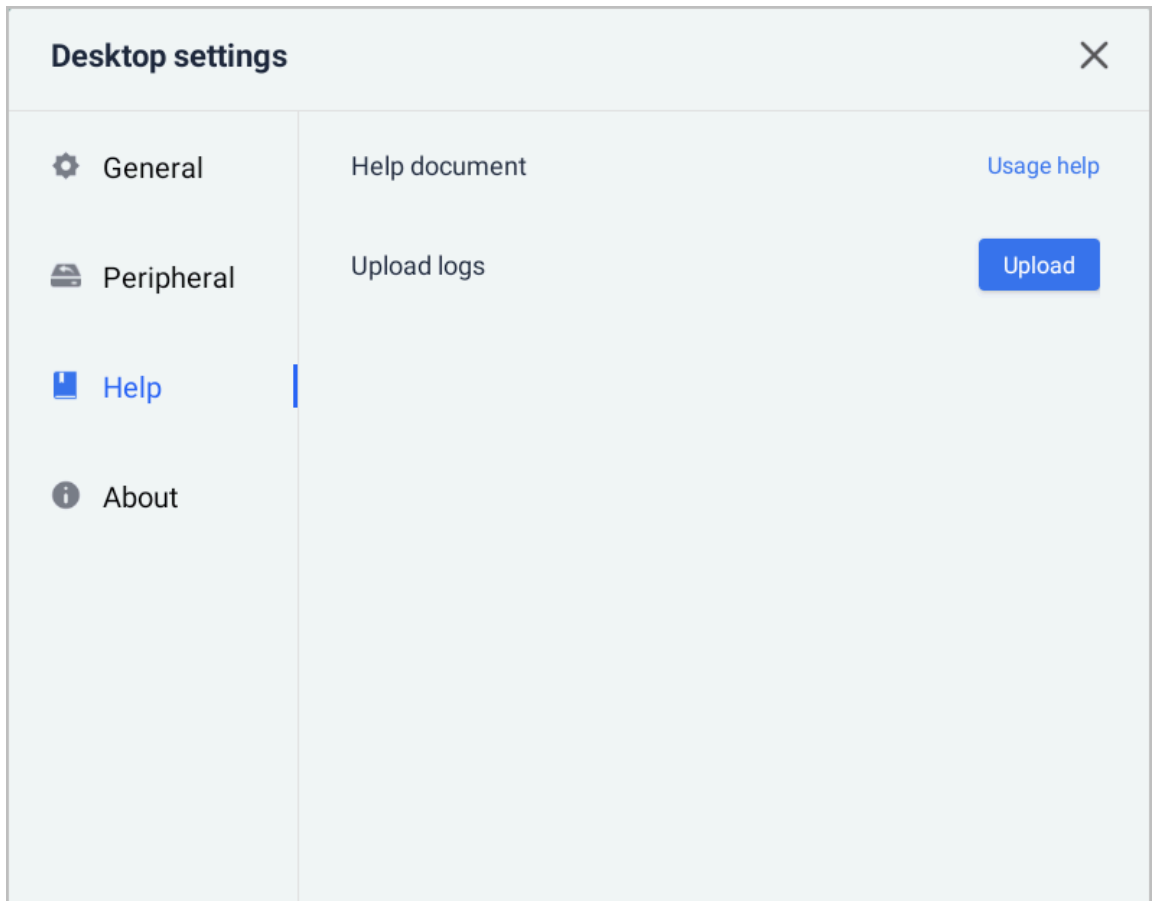

4. Perform the following operations as required.

To...	Do...
View the cloud desktop help document	Click Usage Help . The Help dialog box is displayed.

To...	Do...
Upload logs	Click Upload to upload logs to the server.

8.5 Viewing the Privacy Policy

Abstract

In the **Desktop Settings** window, you can view the privacy policy description.

Steps

1. After logging in to the cloud desktop, move the mouse pointer to the top center of the cloud desktop. The cloud desktop toolbar is displayed automatically.
2. Click **Preference**. The **Desktop settings** window is displayed.
3. Click **About**. The **About** window is displayed, see [Figure 8-5](#).

Figure 8-5 About Window

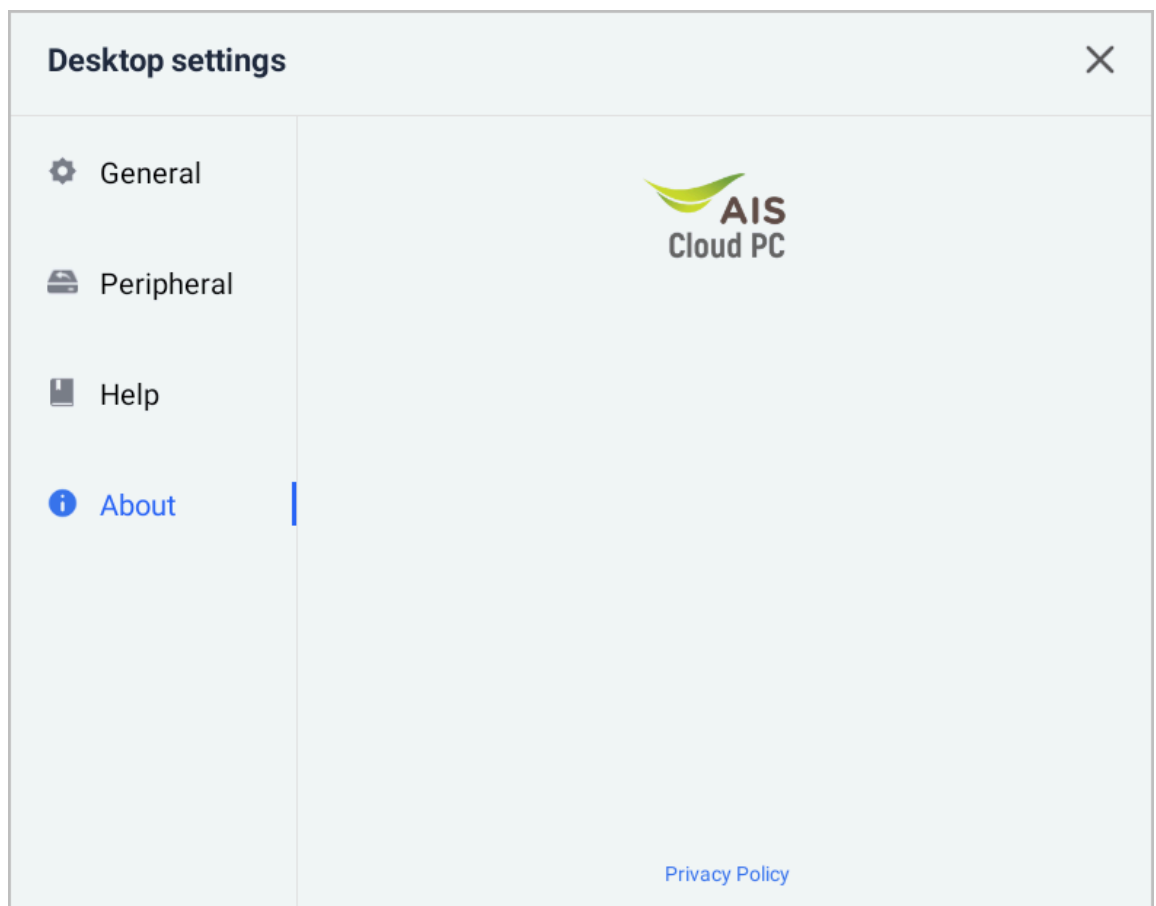

4. Click **Privacy Policy** to view the privacy policy description.

8.6 Checking the Environment Information

Abstract

This procedure describes how to check the network status between the terminal and the cloud server for fault location.

Steps

1. After logging in to the cloud desktop, move the mouse pointer to the top center of the cloud desktop. The cloud desktop toolbar is displayed automatically.
2. Click **Environment detection**. The **Environment detection** window is displayed.

Figure 8-6 Environment Detection Window

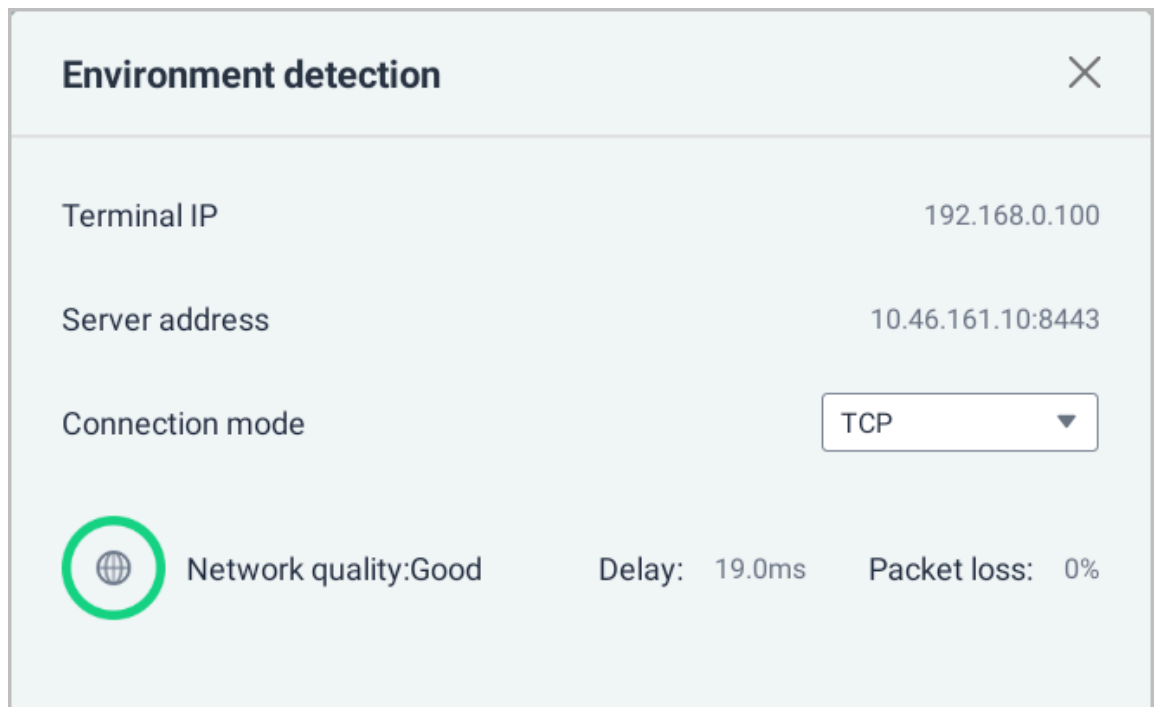

3. Select an option from the **Connection mode** list to view the corresponding network environment information.

8.7 Restarting a Cloud Desktop

Abstract

If the cloud desktop fails, you can use the forced restart function to restart the cloud desktop.

Notice

Before the restart, it is recommended that you save the related files and exit the programs, to avoid data loss.

**Note**

After the terminal is disconnected from the cloud desktop, you can shut down, restart, or forcibly reboot the cloud desktop on the cloud desktop list screen shown in [Figure 6-13](#).

Steps

1. After logging in to the cloud desktop, move the mouse pointer to the top center of the cloud desktop. The cloud desktop toolbar is displayed automatically.
2. Click **Restart**. The confirmation dialog box is displayed.
3. Click **Confirm**.

Chapter 9

Recommended Devices

Device	Recommended Model	Description
Power adapter	Output : 5 V DC, 2.0 A	-
USB to Ethernet adapter	UGREEN 30304	-
USB hub with an Ethernet port	UGREEN 30298	-
USB hub without an Ethernet port	-	Standard peripherals are supported.
HDMI to VGA adapter	UGREEN 40248	Connect with a HDMI cable if the display device supports HDMI input.